

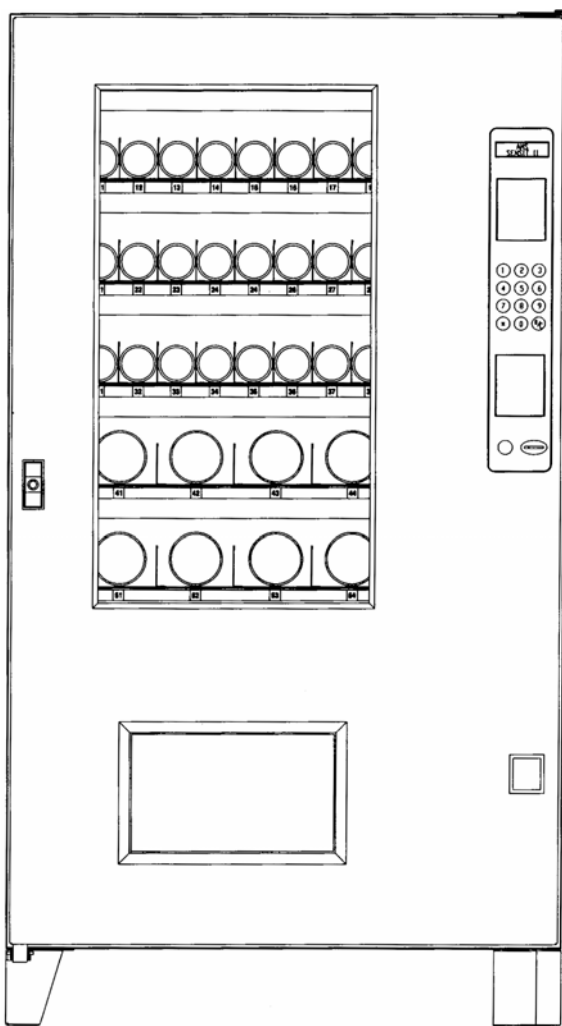

## SENSIT II OPERATION AND SERVICE MANUAL



**Glass Front Vendor  
Model 39**

**Frozen Food (FV)**

AUTOMATED MERCHANDISING SYSTEMS INC  
255 WEST BURR BLVD.  
KEARNEYSVILLE, WV 25430  
304-725-6921, Fax 304-725-6983

[www.amsvendors.com](http://www.amsvendors.com)  
[info@amsvendors.com](mailto:info@amsvendors.com)

INTERNATIONAL A.M.S. S DE RL DE CV  
KM. 9 CARR. AL CASTILLO NO. 8200  
MPIO. DE EL SALTO, JAL. MEXICO 45680  
5233-36-88-07-17, Fax 5233-3-6-88-13-14

[www.amsint.com.mx](http://www.amsint.com.mx)  
[servicio@amsint.com.mx](mailto:servicio@amsint.com.mx)

## TABLE OF CONTENTS

<u>Para</u>	<u>Title</u>	<u>Page</u>		<u>Page</u>
	<b>TABLE OF CONTENTS</b>	<b>i</b>	3.5.1 Display	3-2
	<b>TABLE OF FIGURES</b>	<b>iii</b>	3.5.2 Keypad	3-2
<b>1</b>	<b>INTRODUCTION</b>	<b>1-1</b>	3.5.3 Changer Location	3-2
1.1	SENSIT II SYSTEM	1-1	3.5.4 Validator/Debit Card Reader Locations	3-2
1.1.1	Guaranteed Delivery	1-1	3.5.5 Coin Box	3-2
1.1.2	Instant Refund	1-1	3.5.6 Door Switch	3-2
1.1.3	Automatic Helix Adjustment	1-1	3.5.7 Coin Return Button	3-2
1.1.4	Additional Benefits	1-1	3.6 REFRIGERATION OPERATION	3-2
1.2	HEALTH AND SAFETY	1-1	3.6.1 Refrigeration Operation	3-2
1.2.1	H&S Specifications	1-1	3.6.2 Temperature Control	3-2
1.2.2	H&S Software	1-1	3.6.3 Refrigeration Control	3-3
1.2.3	H&S Protection	1-1	3.7 TRAY RAILS	3-3
1.3	MODEL IDENTIFICATION	1-1	3.8 TRAYS	3-3
1.3.1	Model Number Breakdown	1-2	3.8.1 Vend Motors	3-3
1.3.2	Serial No. and Date Code Breakdown	1-2	3.8.2 Helixes	3-3
1.4	GENERAL SPECIFICATIONS	1-2	3.8.3 Divider	3-3
1.4.1	Operating Environment	1-2	3.8.4 Pusher Bar	3-3
1.4.2	Overall Physical Dimensions	1-2	3.9 ELECTRICAL PANEL	3-3
1.4.3	Vendor Weight	1-2	3.9.1 Transformers	3-3
1.4.4	Power Requirements	1-2	3.9.2 RF Filter	3-3
1.4.5	Refrigerant Specifications	1-2	3.9.3 Relay	3-3
1.4.6	Coin Mechanisms and Bill Validators	1-2	3.9.4 Ballast	3-3
1.5	VENDOR CAPACITY	1-2	3.9.5 Power Distribution Harness	3-3
1.6	PATENT DISCLOSURE	1-2	3.9.6 Ground	3-3
<b>2</b>	<b>SAFETY</b>	<b>2-1</b>	3.10 FUSE AND POWER SWITCH	3-3
2.1	COMMITMENT TO SAFETY	2-1	3.10.1 Fuse	3-3
2.2	SAFETY PRECAUTIONS	2-1	3.10.2 Power Switch	3-4
2.2.1	High Voltage Contact	2-1	3.11 SLIDING DOOR	3-4
2.2.2	Improper Grounding	2-1	<b>4 VENDOR PREPARATION AND INSTALLATION</b>	<b>4-1</b>
2.2.3	Fan Contact	2-1	4.1 CONFIRMING POWER AT OUTLET	4-1
2.2.4	Helix Motion and Jamming	2-1	4.1.1 Checking the Outlet (US & Canada)	4-1
2.2.5	Refrigerant Release	2-1	4.1.2 Checking the Outlet (Outside US & Canada)	4-1
2.2.6	Vendor Tipping	2-2	4.1.3 Electrical Requirements for CE Compliance	4-1
2.2.7	Other Improper Conditions	2-2	4.1.4 Requerimiento de Servicio Eléctrico Para Certificación CE	4-1
2.3	TEST STANDARDS	2-2	4.1.5 Les Utilites Electriques Necessaire Pour Conformement Aux Regles CE	4-1
2.3.1	ANSI/UL 541 Refrigerated Vending Machines	2-2	4.2 VENDOR PREPARATION	4-2
2.3.2	ANSI/UL 751 Safety for Vending Machines	2-2	4.2.1 Inspection	4-2
2.3.3	Additional Standards	2-2	4.2.2 Mounting and Connecting Bill Validators and Card Readers	4-2
<b>3</b>	<b>VENDOR SYSTEMS/COMPONENTS</b>	<b>3-1</b>	4.2.3 Mounting and Connecting Coin Mechanism	4-2
3.1	SENSIT II SYSTEM OPERATION	3-1	4.2.4 Determine Product Loading	4-2
3.2	CONTROL BOARD	3-1	4.2.5 Configuring Motors	4-2
3.2.1	Program Chip	3-1	4.2.6 Installing Price Labels	4-3
3.2.2	Mode Switch	3-1	4.2.7 Setting Prices	4-3
3.2.3	DEX Jack	3-1	4.3 ON-SITE INSTALLATION	4-3
3.3	VEND SENSORS	3-1	4.3.1 Remove Shipping Boards	4-3
3.3.1	Primary	3-1	4.3.2 Placing the Vendor in Location	4-3
3.3.2	Secondary	3-1	4.3.3 Leveling the Vendor	4-3
3.4	INTERFACE BOARD	3-2	4.3.4 False Leg Installation	4-3
3.5	DOOR	3-2	4.3.5 Initial Power-Up and Cool-down	4-4

<b>5</b>	<b>TRAY ADJUSTMENT AND CONFIGURATION</b>	<b>5-1</b>	6.10	OPTIONS	6-4
			6.10.1	Message	6-4
			6.10.2	Prize	6-4
5.1	VEND TRAY	5-1	6.10.3	Language	6-5
5.1.1	Removal	5-1	6.10.3.1	Primary	6-5
5.1.2	Installation	5-1	6.10.3.2	Secondary	6-5
			6.10.3.3	Create Custom	6-5
5.2	TRAY VERTICAL POSITIONS	5-1	6.10.4	Product Sensor	6-5
5.2.1	Removal	5-1	6.10.5	Speech	6-5
5.2.2	Installation	5-1			
5.3	TRAY COLUMN ADJUSTMENTS	5-1	6.11	SALES BLOCKING	6-5
5.4	CHANGING DIVIDERS	5-1	6.12	CLOCK SETTINGS	6-5
5.5	CHANGING HELIXES	5-2	6.13	FREE VEND	6-5
5.6	HELIX ADAPTER	5-2	6.14	AUXILIARY OUTPUT	6-5
5.7	HELIX EJECTOR	5-2	6-15	PROGRAM QUICK REFERENCE	6-6
5.8	HELIX ALIGNMENT DEVICE	5-2	<b>7</b>	<b>TROUBLESHOOTING</b>	<b>7-1</b>
5.9	MOTOR POSITIONS	5-2	7.1	OUT OF SERVICE ERRORS	7-1
5.10	AVOIDING PRODUCT HANG-UPS	5-2	7.2	HEALTH AND SAFETY ERRORS	7-1
5.11	TALL PRODUCT VENDING	5-2	7.3	MACHINE ERROR CODES: CAUSES AND SOLUTIONS	7-1
5.12	PUSHER BAR INSTALLATION	5-2	7.3.1	VIEWING TOP LEVEL ERROR CODES	7-1
			7.3.2	VIEWING SUB-LEVEL ERROR CODES	7-1
			7.3.3	ERROR CODE CHART: CAUSES AND SOLUTIONS	7-2
<b>6</b>	<b>SERVICE PROGRAMMING</b>	<b>6-1</b>	7.4	CLEARING JAMMED MOTOR	7-3
	SERVICE MODE	6-1	7.5	ICE FORMATION IN THE CABINET	7-3
6.1	ERROR CODES	6-1	7.6	MACHINE TROUBLESHOOTING CHART	7-3
6.2	ACCOUNTING DATA	6-1	<b>8</b>	<b>MAINTENANCE</b>	<b>8-1</b>
6.3	DATA LOGS	6-1	8.1	REPLACING THE PROGRAM CHIP	8-1
6.4	FILL/DISPENSE	6-1	8.2	CLEANING THE REFRIGERATION UNIT AND SCREENS	8-1
6.5	DELAYED SALES	6-1	8.3	CLEANING THE VENDOR CABINET	8-1
6.6	TEMPERATURE	6-2	8.4	CLEANING THE PLASTIC DOOR LINER	8-1
6.7	PRICE SETTINGS	6-2	8.5	CLEANING THE GLASS WINDOW	8-1
6.7.1	Set Prices	6-2	8.6	LUBRICATION WITH LITHIUM GREASE	8-2
6.7.2	ValueVend	6-2	8.7	REPLACING FLOURESCENT BULBS	8-2
6.8	TRAY SETUP	6-3	8.8	DEFROSTING THE EVAPORATOR COIL	8-2
6.8.1	Test Motors	6-3	8.9	TESTING THE TEMPERATURE SYSTEM (H & S)	8-2
6.8.2	Link Motors	6-3	8.10	PC UTILITY LOADING INSTRUCTIONS	8-2
6.8.3	Delayed Stop	6-3	8.10.1	Requirements	8-2
6.8.4	Configure	6-3	8.10.2	Installation	8-2
6.9	MDB (MULTI-DROP BUS)	6-3	8.10.3	Startup	8-3
6.9.1	Settings	6-3	8.10.4	Toolbar	8-3
6.9.1.1	Force Vend	6-3	8.10.5	Program Screens	8-3
6.9.1.2	No Cheat	6-3	8.10.6	Software Operation	8-4
6.9.1.3	Change Bill	6-3	8.10.7	Shutdown	8-4
6.9.1.4	Hold Lost Credit	6-3	8.10.8	Errors	8-4
6.9.1.5	Multi-Vend	6-3			
6.9.1.6	Lev2 Coin Mech	6-3			
6.9.1.7	Instant Reval	6-3			
6.9.1.7.1	Bill and Cash-Less Applications	6-3			
6.9.1.7.2	MDB Out-Of-Service	6-4			
6.9.1.7.3	Remaining in Service Without Coin Mech	6-4			
6.9.1.7.4	'#' Key For Escrow Return	6-4			
6.9.1.7.5	Bill-Only Application Notes	6-4			
6.9.1.7.6	Bill Plus Cash-Less Application Notes	6-4			

8.11	REPLACING THE POWER CORD	8-5	Figure 3.1	Control Board Components	3-1
8.12	STORING THE VENDOR	8.5	Figure 4.1 Figure 4.2	Tip-Over Warning False Leg Installation	4-3 4-4
<b>9</b>	<b>WIRING DIAGRAM</b>	<b>9-1</b>	Figure 5.1 Figure 5.2	Large Product Vending Pusher Bar Installation	5-2 5-2
<b>10</b>	<b>SUPPORTED DEX FIELDS</b>	<b>10-1</b>	Figure 8.1	Replacing Control Chip	8-1
<b>11</b>	<b>OPTIONAL EQUIPMENT</b>	<b>11-1</b>	Figure 8.2 Figure 8.3	Harness, Chip Programming Replacing The Power Cord	8-4 8-6
<b>12</b>	<b>WARRANTY</b>	<b>12-1</b>	Figure 9.1	Typical Wiring Diagram (Sheets 1 – 4)	9-1/9-4

**TABLE OF FIGURES**

<u>NUMBER</u>	<u>NAME</u>	<u>PAGE</u>
Figure 1.1	Vendor Serial Plate	1-2
Figure 1.2	FV Cabinet Dimensions	1-3
Figure 1.3	FV Capacity – 116 Units	1-4
Figure 1.4	FV Capacity – 120 Units	1-4
Figure 1.5	FV Helix Capacities	1-5

**PUBLICATION NOTICE**  
L0097D, ECN 1932, 05-05-2008

It is our intent to assist our customers with up-to-date documentation; however, this manual may not contain all updates and is subject to revision without notice. Please contact our Service Department with your requests or comments.





## 1.0 INTRODUCTION

Congratulations on the purchase of your new AMS Sensit II vendor. All Sensit II models, including Snack, Visi-Combo, Bottle and Food Combo, Visi-Diner and Milk, are versatile, high-capacity vending machines. AMS machines are designed, tested, and built to provide years of reliable, low-maintenance service in an indoor environment. A fully insulated cabinet, DEX data capability, and flexible product configuration are just some of the many standard features built into every AMS merchandiser.

See the table which follows for the capabilities of your new vendor:

FV (FROZEN FOOD VENDOR)		
CAPABILITY	TEMPURATURE	PROTECTION
SNACK	75°F TO 42°F (24°C TO 5°C)	NONE
REFRIGERATED FOOD	41°F OR COLDER (5°C)	H&S
SLACKED FOOD	25°F OR COLDER (-4°C)	H&S
FROZEN FOOD	0°F OR COLDER (-18°C)	H&S

### 1.1 SENSIT II SYSTEM

Your vendor is equipped with the Sensit II system. The Sensit II system is a patented vend-sensing system that detects when products fall into the delivery bin. Basically, a plane of infra-red light is created across the top of the delivery bin, and the Sensit II system can detect when the light has been blocked by a falling product. Using this technology, the vendor “knows” when your customer gets the product. The Sensit II system has several important benefits:

#### 1.1.1 Guaranteed Delivery

When a product is selected the sliding door will open and the helix will turn. If, after one revolution, the product hangs up or an opening was missed in loading, the helix will rotate three additional half-revolutions to make sure the product is delivered. The sliding door will then close. No more hitting or shaking the vendor to get products that did not fall!

#### 1.1.2 Instant Refund

If the customer does not receive a product, he can receive a full refund by pressing the coin return, or he can select another product. No more refund requests!

#### 1.1.3 Automatic Helix Adjustment

With the Sensit II system, the helix stops as soon as the product falls. The sliding door will close. It is no longer necessary to adjust the home position of the helix for each different package. In fact, different packages can be loaded in the same column. No more double vending!

#### 1.1.4 Additional Benefits:

1. Opening the delivery bin door will not affect the Sensit II system. The sensors are located above the delivery bin and will not be blocked by the bin door. Product that

falls while the door is open will still pass through the beam.

2. Opening the door of a cold vendor will cause some condensation to form inside. The Sensit II system will not allow vending until this fogging clears, normally within a few minutes of closing the door.

### 1.2 HEALTH AND SAFETY

#### 1.2.1 H&S Specifications

AMS vendors intended for vending perishable food products meet NAMA requirements for frozen food vending machines. The NAMA specifications for frozen food product vendors require that the temperature in the vendor must cool to 0°F for frozen and to 25°F for slack within 75 minutes of closing the vendor door or an error will be generated and the vendor will not allow sales. (note that Delayed Sales has no effect on this cool-down period). This is to allow a recovery period following loading; however, all products should be frozen prior to loading. After the cool-down requirement has been met, if the temperature in the vendor exceeds 0°F for more than 15 minutes an error will be generated and the vendor will not allow sales.

#### 1.2.2 H&S Software

To meet these requirements, all AMS refrigerated food vendors have control software with a built-in Health & Safety (H&S) function. The H&S function is activated automatically when the temperature is set to 0°F or below. Unless otherwise specified by regulatory agencies, AMS recommends setting the temperature to -1°F when vending frozen food products.

#### 1.2.3 H&S Protection

In the event the temperature exceeds the NAMA specifications following the recovery period or during normal operation, an error will be generated and the vendor will not allow sales. This protects the consumer from purchasing spoiled food. H&S error codes are detailed in Section 7.4.

### 1.3 MODEL IDENTIFICATION

When requesting service, replacement parts or technical assistance, please refer to the vendor Serial Plate (refer to Figure 1.1). It is attached inside the door near the upper right corner of the window and is visible from the outside. The information contained on this plate is necessary to determine what parts, kits, or maintenance should be applied to your specific model.

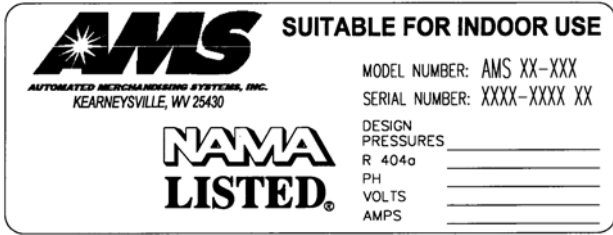
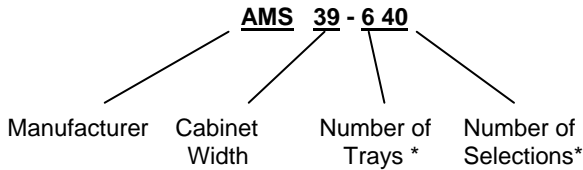
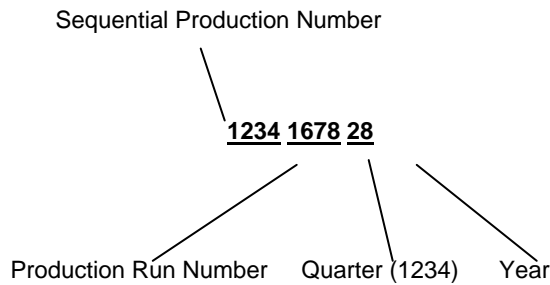

Figure 1.1 Vendor Serial Plate

1.3.1 Model Number Breakdown (refer to Figure 1.1)



1.3.2 Serial Number and Date Code Breakdown (refer to Figure 1.1)



**Example:** 1234-1678-28 would be translated as sequence number 1234 of production run 1678, manufactured in the second quarter “2” of 2008.

The Production Run Number of machines built in the U.S. starts with the number 1 or any odd number. The Sequential Production Number of machines built in Mexico starts with the number 0 or any even number.

1.4 GENERAL SPECIFICATIONS

1.4.1 Operating Environment

AMS vendors are designed for indoor use only. Indoor temperatures must be between 45°F (7°C) and 110°F (43°C). Maximum temperature for vendors with perishable food is 100°F (38°C). The vendor should not be located in an area where it may be subjected to a water jet or rain.

1.4.2 Cabinet Physical Dimensions (refer to Figure 1.2): 39”W x 72”H x 36”D (99 cm x 183 cm x 91 cm)

1.4.3 Vendor Weight: Approx. 738 lbs. (335 kg)

1.4.4 Power Requirements:

United States, Canada and Mexico: 115 VAC, 60 Hz

International: 230 VAC, 50/60 Hz

Frozen Food (FV) 10.8 amps @115 VAC (1242 watts)  
5.6 amps @220 VAC (1242 watts)

1.4.5 Refrigerant Specifications: ¼ HP, R-404A, 19.5 oz. (.55 kg)

1.4.6 Coin Mechanisms and Bill Validators

AMS vendors will support all NAMA-approved Multi-Drop Bus (MDB) coin mechanisms, bill validators and card readers. Where applicable, it will also support the “Executive Mechanism” Coin Changer.

1.5 VENDOR CAPACITY:

Capacity depends on configuration (refer to Figures 1.3, 1.4 and 1.5 on the following pages)

1.6 PATENT DISCLOSURE

This vendor and/or certain of its components are covered by one or more of the following U.S. and International patents;

U.S.	6,041,962
	6,145,699
	6,202,888
	6,384,402
	6,520,373
	6,708,079
	6,794,634
	7,191,915
	7,246,719
	7,343,220 B2
Canada	2,329,314
Mexico	230714



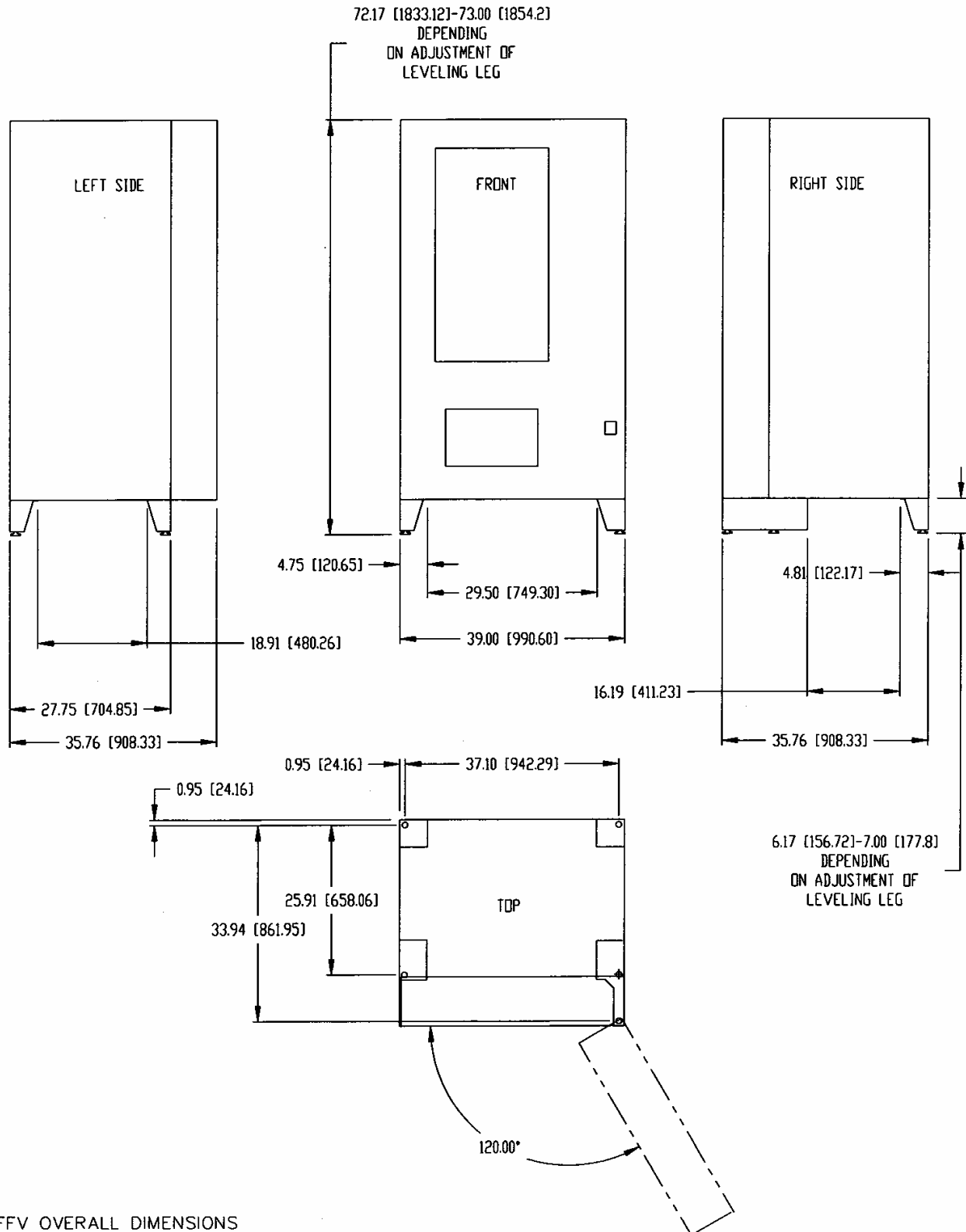

FFV OVERALL DIMENSIONS

Figure 1.2 FV Cabinet Dimensions  
(For Reference Only)

5	5	5	5
5	5	5	5
5	5	5	5
7	7	7	7
7	7	7	7

FV - 116 UNITS

Figure 1.3 FV CAPACITY - 116 UNITS

5	5	5	5
7	7	7	7
6	6	6	6
6	6	6	6
6	6	6	6

FV - 120 UNITS

Figure 1.4 FV CAPACITY - 120 UNITS

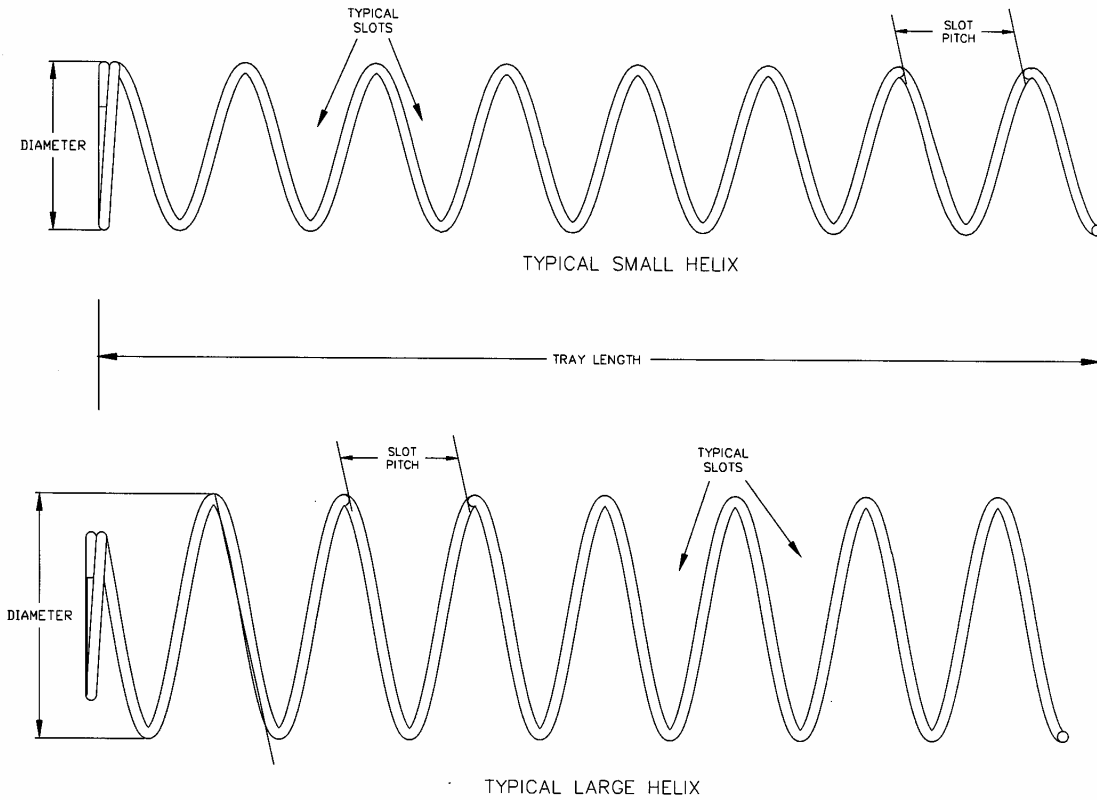

Available Helix Sizes:				
Name	P/N	Pitch	Slot Opening	Note
3.75 Inch (95.2mm) Counter-Clockwise	22518-04	4 Pitch	3.46" (87.8mm)	
	22518-05	5 Pitch	2.91" (73.9mm)	
	22518-07	7 Pitch	2.2" (55.8mm)	
	22518-09	9 Pitch	1.77" (44.9mm)	
	22518-11	11 Pitch	1.48" (37.6mm)	
2.6 Inch (66mm) Counter-Clockwise	22519-04	4 Pitch	3.46" (87.8mm)	
	22519-05	5 Pitch	2.91" (73.9mm)	
	22519-07	7 Pitch	2.2" (55.8mm)	
	22519-09	9 Pitch	1.77" (44.9mm)	
	22519-11	11 Pitch	1.48" (37.6mm)	
2.6 Inch (66mm) Clockwise (See Note)	22520-04	4 Pitch	3.46" (87.8mm)	Use with 22519-04
	22520-05	5 Pitch	2.91" (73.9mm)	Use with 22519-05
	22520-07	7 Pitch	2.2" (55.8mm)	Use with 22519-07
	22520-09	9 Pitch	1.77" (44.9mm)	Use with 22519-09
	22520-11	11 Pitch	1.48" (37.6mm)	Use with 22519-11

NOTE: Pair clockwise helices with counter-clockwise helices of the same pitch when using dual helix motors.

Figure 1.5 FV HELIX CAPACITIES



## 2.0 SAFETY

### 2.1 COMMITMENT TO SAFETY

Automated Merchandising Systems Inc. is committed to designing and producing a safe product. As with all electrical or mechanical pieces of equipment, potential hazards exist. It is the intent of Automated Merchandising Systems, through this manual and service technician training, to alert individuals who will be servicing our equipment to these potential hazards, and to provide basic safety guidelines.

To reduce the risk of serious injury or death, please read and follow all warnings in this manual. It is important that we point out that these warnings are not comprehensive. Automated Merchandising Systems can not possibly anticipate all of the ways that service may be conducted, nor all of the possible safety hazards that may result from such service. Therefore at all times we urge you to beware of hazards such as electrical shock, mechanical entrapment, and tipping a vendor during movement.

Automated Merchandising Systems strongly recommends a commitment to safety on the part of all servicing personnel or organizations. Only personnel properly trained in vendor servicing should attempt any service to the internal components of the vendor. It is important to point out that Automated Merchandising Systems has no control over the vendor once it leaves our factory. **Maintaining the vendor in a safe condition is the sole responsibility of the owner.**

If you have questions concerning safety or service, or would like more information, please contact the Automated Merchandising Systems Service Department at 304-725-6921 or e-mail info@amsvendors.com.

### 2.2 SAFETY PRECAUTIONS

Below are listed safety precautions and safe practices to follow to avoid injury from selected hazards. This list can not possibly cover all hazards, therefore please remember to **THINK SAFETY FIRST**.

#### 2.2.1 High Voltage Contact

Each vendor is designed to operate on a specific voltage, either single phase 115VAC 60Hz or 220-240VAC 50-60Hz, depending on the country. The voltage is specified on the serial plate (refer to Section 1.3 Model Identification). High voltage areas include the electrical panel, the refrigeration unit and fans, and the fluorescent lamps. It is important to understand that contact with the high voltage wiring can result in injury or death.

1. Always test the outlet for proper voltage, polarity and grounding before plugging in the vendor.
2. Always disconnect power to the vendor before servicing. Allow only fully trained service technicians to service the vendor if service must be performed with the power on.
3. Always keep electrical connections dry. Do not place the vendor in or near standing water.
4. Never use a worn or damaged power cord.

#### 2.2.2 Improper Grounding

Some electrical components have a green or green/yellow ground wire attached to a grounding point in the vendor. If it becomes necessary to remove a ground wire during service, note how the wire is attached, including the locations of any washers. After servicing, make sure that the wires and washers are replaced exactly as they were. Note that the vendor may appear to work normally without the ground wires, but there will be a potential shock hazard from ungrounded components.

1. Always test the outlet for proper grounding before plugging in the vendor.
2. Always reconnect ground wires after servicing.
3. Test the ground fault circuit interrupter (GFCI) periodically to insure proper operation.

#### 2.2.3 Fan Contact

The vendor refrigeration unit is equipped with electric fans which can start automatically. These fans are enclosed to prevent accidental contact. The electrical power must be disconnected before removing the unit from the vendor.

1. Always disconnect power to the vendor before servicing.
2. Always keep covers in place.
3. Always wear hand and eye protection when servicing the vendor.
4. Always keep hair and loose clothing tied back.
5. Never insert hands or tools into concealed areas.

#### 2.2.4 Helix Motion and Jamming

Energized vend motors can turn a helix with considerable torque, creating a possible entrapment hazard. Also, turning helixes may eject tools or other objects left on trays. A helix that is jammed or caught can store energy as it binds, which can cause it to twist or spring outward suddenly even if power is disconnected. Use caution when freeing a jammed helix.

1. Always disconnect power to the vendor or control board before servicing the vend motors.
2. Always check for proper fit when loading products in helixes to avoid jamming.
3. Always restrain the helix before freeing a jammed or caught helix.
4. Always wear hand and eye protection when servicing the vendor.
5. Always keep hands, hair, loose clothing and tools away from moving parts.

#### 2.2.5 Refrigerant Release

It should also be noted that releasing refrigerant to the atmosphere is a federal crime and is punishable by law. Any service work requiring the system to be opened must be performed by a licensed technician using certified equipment. Unauthorized service to the sealed refrigerant system may void the warranty.

The refrigeration system is pressurized and sealed at the factory. Puncturing or cutting any component in the system will cause refrigerant gas and liquid to be propelled out of the system, creating an immediate physical hazard. Use caution to avoid accidentally opening the refrigerant system.

1. Never puncture or cut any component in the refrigeration system.
2. Always use licensed service technicians to service the refrigeration system.
3. Always wear hand and eye protection when servicing the vendor.

### 2.2.6 Vendor Tipping

The empty weight of the vendor is approximately 800 pounds. A falling vendor can cause serious injury or death. Caution should always be taken to avoid dropping or tipping a vendor.

1. Never rock or tip the vendor. It must be kept upright for safe operation.
2. Never place the vendor in an inclined position, such as on a ramp or with all the legs not on the same horizontal surface.
3. Never place the vendor in a moving environment such as on a ship without properly securing it in place.
4. Never place the vendor in a location where it may be struck by a vehicle.
5. Never transport an unsecured vendor.
6. Never attempt to lift or move the vendor by hand.
7. Always use lifting equipment with the proper load rating. Note that the Specification weight listed is empty weight.

### 2.2.7 Other Improper Conditions

Hazardous conditions can be created by improper use or service of the vendor.

**WARNING:** Do not use electrical appliances, including heaters, inside the vendor.

1. Always reinstall all parts removed during service to their original locations, including screws, bolts and other fasteners.
2. Never make unauthorized modifications to any part of the vendor.
3. Always replace components that are worn, broken, or otherwise unfit for use.
4. Never use unauthorized parts, or use parts for anything other than their intended application.

### 2.3 TEST STANDARDS

AMS vending machines bearing the ETL mark have been tested and comply with one of the following standards:

- 2.3.1 Standard for Refrigerated Vending Machines ANSI/UL 541 and the Standard for Refrigeration Equipment, CAN/CSA C22.2 No. 120
- 2.3.2 Standard for Safety for Vending Machines ANSI/UL 751 and the Standard for Vending Machines, Consumer and Commercial Products (CAN/CSA C22.2 No. 128)
- 2.3.3 Additional Standards  
Certain models comply with the following:
  - 2.3.3.1 European Union  
European Economic Area  
CE (European Conformity)
  - 2.3.3.2 2007 Appliance Efficiency Regulations  
CEC-400-2007-016-REV1
  - 2.3.3.3 Natural Resources Canada (NRCan)  
Energy Efficiency Regulations, OEE

## 3.0 VENDOR SYSTEMS AND COMPONENTS

### 3.1 SENSIT II SYSTEM OPERATION

1. The Sensit II system is comprised of the control logic board, the interface board, the primary sensor, and the secondary sensor. Both primary and secondary sensor boards contain infra-red emitters and detectors. When installed at the ends of the delivery bin, the emitter on one board at one end is being detected by the detectors on the board on the opposite end. The control board controls the performance of the vending operation.
2. When a selection is made, the interface board will open the sliding door. The column motor will begin to run. After several seconds, if no product falls in the hopper, the motor will be stopped, the sliding door will close, the credit will be maintained and the customer will be directed to "PLEASE MAKE ANOTHER SELECTION."
3. When the controller measures a variation in the light intensity during the vend cycle, it recognizes that a product has fallen through the light into the hopper. The interface board will close the sliding door, the controller will stop the vend motor and the credit is removed.
4. When the vendor door is opened for loading or service, the clear lens on the sensor protective cover can become fogged up, particularly in hot or humid locations. In these cases, the vendor will display "SENSIT BLOCKED – UNABLE TO VEND" until the fogging has cleared, usually within minutes after closing the door.

### 3.2 CONTROL BOARD

The control board contains a program chip which controls and monitors the vendor, DEX, and the mode switch used to enter service mode. The control board is located in the upper left hand corner of the open vendor door, behind an access door. See Figure 3.1.

#### 3.2.1 Program Chip

The program chip contains the software that controls vending and refrigeration (refer to Figure 3.1). The software can be upgraded by replacing the chip or by uploading new software through the DEX plug, but please note that all settings such as pricing and motor configuration will have to be reprogrammed. Refer to Section 8.0 for replacing the control chip or software.

#### 3.2.2 Mode Switch

Pressing the mode switch (refer to Figure 3.1) switches from vend mode to service mode. Use service mode to change settings, access vend data, and check error codes for troubleshooting. Data is displayed on the front display panel, and is entered entered at the front selection panel. Pressing the switch again or simply closing the vendor door will automatically switch the control board to vend mode.

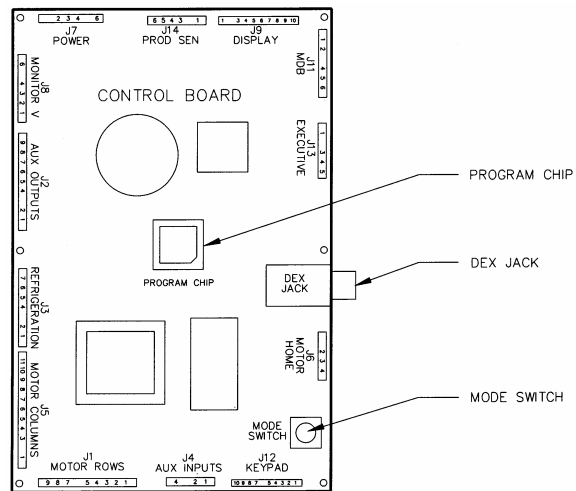

#### 3.2.3 DEX Jack

The DEX jack (refer to Figure 3.1) is provided for downloading detailed vend data and uploading new control board software.

### 3.3 VEND SENSORS

#### 3.3.1 Primary Sensor

The primary sensor is located on the left of the delivery bin when viewing the back of the door. The primary sensor, inside a protective cover, receives the light emitted from the secondary sensor and sends a signal to the control board based on the intensity of the beam. When a product drops into the delivery bin, it causes a change in light intensity which is interpreted by the control as a successful vend.

When servicing the primary sensor be mindful of the emitter and the black detector cells along the top of the board. These can be knocked out of alignment or damaged by rough handling.

The primary and secondary sensors function in an identical fashion: however, the primary board incorporates various connection for temperature, control, and secondary sensor harnesses.

If a product sensor is used, the sensor on the left end connects to the primary sensor with a single small harness.

#### 3.3.2 Secondary Sensor

The secondary sensor is located on the right end of the delivery bin when viewing the back of the door. The secondary sensor, inside a protective cover, receives the light emitted from the primary sensor and sends a signal to the control board based on the intensity of the beam. When a product drops into the delivery bin, it causes a change in light intensity which is interpreted by the control as a successful vend.

When servicing the secondary sensor be mindful of the emitter and the black detector cells along the top of the

Figure 3.1 Control Board Components

board. These can be knocked out of alignment or damaged by rough handling.

The primary and secondary sensors function in an identical fashion: however, the secondary board is connected to the primary by a single harness.

If a product sensor is used, the sensor on the right end connects to the secondary sensor with a single small harness.

### 3.4 INTERFACE BOARD

The interface board is mounted inside the right rail mount, behind the steel panel.

The interface board is an input/output device under the control of the control board.

The interface board controls the sliding door, the defrost functions and the evaporator fan motor.

## 3.5 DOOR

### 3.5.1 Display

The display is located on the front of the door. It serves as the interface for using and programming the machine. In service mode, it displays the active function and parameter values. In vend mode it can display the selection entered, the price of a selected item and the credit accumulated. When the machine is idle it can display the time and a scrolling message.

When the asterisk key is pressed the display also indicates the chiller status, shown in the lower right corner of the temperature display.

- = Chiller off due to open door
- V = Chiller off due to low voltage
- D = Chiller off due to defrost timer
- P = Chiller off due to pressure timer
- % = Chiller can run, subject to temperature set-point and EnergySENSIT

The number displayed before the % sign indicates the % of time the compressor has been running in the previous 4 hours.

In case of multiple reasons for a chiller not running the display will show the foremost reason listed (i.e., door open takes precedence over low voltage).

### 3.5.2 Keypad

The keypad is located below the display on the front of the door. A vending selection is made by keying in the number combination that corresponds to the location of an item in the machine. The keypad is also used to enter data when the vendor is in service mode.

### 3.5.3 Changer Location

Three screws are installed just below the coin chute. These screws mate to the keyhole slots on the back of the changer. Refer to Section 4.2.4 Mounting And Connecting Coin Mechanism.

### 3.5.4 Validator & Debit Card Reader Locations

There are two locations that will accept bill validators and debit card readers. The lower position meets the guidelines of the Americans with Disabilities Act (ADA) for

access by handicapped persons. Refer to Section 4.2.3 Mounting and Connecting Bill Validators and Card Readers

### 3.5.5 Coin Box

The coin box is located below the changer, behind a separate door, and is used to hold overflow coins when the changer is full. It is removed by tilting slightly and lifting out.

### 3.5.6 Door Switch

The door switch is mounted on the back of the door. The control uses the door switch to turn off the refrigeration unit when the door is open, and to switch from service mode to vend mode when the door is closed.

### 3.5.7 Coin Return Button

The coin return button is located next to the coin slot. Pressing the coin return button will release bent or irregular coins that are not accepted by the changer. If the machine fails to vend a selection that has been made, pressing the coin return will return the full credit. If the Force Vend option is disabled, it can also return the full credit before a selection is made. If the Bill Changer option is enabled, the coin return will return change for bills inserted in the bill validator.

## 3.6 REFRIGERATION SYSTEM

### 3.6.1 Refrigeration Operation

The compressor compresses refrigerant gas, which increases the pressure and temperature of the gas. As the hot, compressed gas passes through the fan-cooled condenser, it is cooled and condenses to a liquid. This fan draws outside air in through a vent in the door bottom, through the condenser where it removes the heat and is blown out through a vent in the back of the cabinet. This part of the refrigeration system is insulated from the refrigerated part of the cabinet.

Driven by the pressurized gas entering the condenser, the liquid passes through a desiccant dryer and a thermal expansion valve. The thermal expansion valve controls the rate at which the liquid refrigerant enters the evaporator.

Lower pressure in the evaporator allows the liquid to evaporate, which lowers its temperature. An evaporator fan forces air from the refrigerated part of the cabinet across the evaporator, where the air is cooled by transferring heat to the refrigerant. The cooled air is returned to the refrigerated part of the cabinet.

The warmed gaseous refrigerant is then sucked from the evaporator through an accumulator, which traps any liquid refrigerant and allows it to evaporate before entering the compressor. The refrigerant is then sucked into the compressor to be compressed, completing the cycle.

### 3.6.2 Temperature Control

The evaporator fan runs continuously to circulate cooling air within the cabinet. A temperature sensor located near the evaporator measures the temperature of air entering the evaporator. When this temperature is above the temperature setting in the control, the compressor and condenser fan are turned on.

When the temperature falls to 5°F below the adjustable temperature setpoint, the compressor and condenser fan are turned off. Refer to Section 6.6 for setting the temperature setpoint.



### 3.6.3 Refrigeration Control

1. The refrigeration system is operated through the control board. A temperature sensor in the cabinet relays the current temperature to the control.
2. If the temperature is above the setting that has been programmed in by the user, the control sends a 24VDC signal to the refrigeration relay. The energized relay closes to complete the high voltage circuit that powers the compressor and the condenser fan.
3. If the compressor should overheat, a thermal overload removes power to the compressor until it has cooled.
4. The defrost interval can be programmed for 3 to 12 hours, in 1 hour increments. The recommended factory default setting is 3 hours. The entire cycle lasts approximately 14 minutes and the cabinet temperature will rise slightly during this time.
5. When the temperature in the cabinet reaches 5°F cooler than the temperature setting, the control de-energizes the relay breaking the circuit powering the compressor.
6. The control will also shut off the compressor if the door is opened. This is to prevent the evaporator from freezing up after drawing in excessive moisture-laden air.
7. After the compressor has shut down, the control will wait until the compressor has been shut down 15 seconds before restarting the compressor. The delay allows pressure in the system to equalize.

### 3.7 TRAY RAILS

The rails are located inside the cabinet and are used to support the trays. The rails are adjustable up and down in 1" increments. Refer to Section 5.2 Tray Vertical Positions.

### 3.8 TRAYS

#### 3.8.1 Vend Motors

The vend motors are snapped into mounting holes on the back of each tray. Each column has one vend motor which is driven by 24 VDC from the control board. These motors do not have a home position switch. They will stop when the sensor has detected a vend, whether the rotation has been more or less than 360°. Refer to Section 4.2.6 and Section 5.11.

#### 3.8.2 Helixes

There are two sizes of helixes in a vendor, approximately 2.6" and 3.7" in diameter. There are several pitches available in each size. The pitch is determined by counting the number of product openings in the helix. Refer to Figure 1.5 Helix Capacities.

#### 3.8.3 Divider

The divider separates product columns on the tray. Two horizontal slots in the divider allow for the installation of a pusher bar. To remove the divider, push rearward and lift. To install, insert the rear tab in the desired slot, push rearward and then down. Make sure the locking tabs on the bottom have engaged their respective slots and pull forward.

#### 3.8.4 Pusher Bar

The pusher bar keeps products pushed to one side of the column. This is typically used with tall products. The pusher bar is removed by pulling the bar free from the plastic clips. To reinstall, it is easiest to press the bar into the clip using pliers. Refer to Section 5.16 Pusher Bar Installation.

### 3.9 ELECTRICAL PANEL

The electrical panel is located in the recess formed by the right rail mount on the right side of the cabinet, behind an access panel.

#### 3.9.1 Transformer

The transformer reduces the input voltage to 24 volts AC for the control board.

A second transformer reduces the input voltage to 24 volts AC for the window heater.

#### 3.9.2 RF Filter

The filter removes electrical noise from the power supplied to the 24VAC transformer to prevent interference with operation of the control board and software.

#### 3.9.3 Relay

Three relays are used, the evaporator fan relay, the defrost element relay and the chiller unit relay. All are controlled by 24 VDC signals from the control board to close the relay and supply high voltage to the specified component. The fan relay is mounted inside the right rail mount. The other two are mounted on the chiller unit.

#### 3.9.4 Ballast

The ballast provides the necessary power to the fluorescent lamps in the door.

#### 3.9.5 Power Distribution Harness

The power distribution harness splits the incoming power into individual leads for the high voltage components.

#### 3.9.6 Ground

Ground is made through the use of grounding studs or screws at the lower back wall of the right mount. Earth ground and individual ground wires from the high voltage components are attached here.

### 3.10 ELECTRICAL FUSE AND POWER SWITCH

The fuse and switch are located at the bottom of the right rail mount.

#### 3.10.1 Fuse

The fuse contains a 3AG fast-blow fuse to protect the 24 VAC power supply to the control board. A spare fuse is also located inside the front of the fuse holder. The fuse holder is opened by pressing down on the indicated side and pulling out.

**3.10.2 Power Switch**

The power switch is used to disconnect power to the control board. The switch should be used to shut off power before MDB devices are being connected or disconnected, before the control board is being serviced, or before any wiring harness is connected or disconnected.

Unplug the power cord to remove the vendor from all electrical power.

**3.11 SLIDING DOOR**

The sliding door is located under the bottom-most tray and is used to seal off the space between the cabinet and door of the vendor.

When a selection is made, the sliding door will move back, allowing the selection to fall thru the sensors and into the hopper. The sliding door will then move forward against the vendor door to seal off the vendor.

The motor which moves the sliding door is controlled by the interface board.

The seals on all sides of the sliding door have been designed to preserve the temperature inside the vendor when the sliding door is closed.

## **4.0 VENDOR PREPARATION AND INSTALLATION**

Setting up a vendor has been divided into three stages. Step 4.1 confirms power availability at the site where the vendor is to be located. Step 4.2 is vendor preparation accomplished in the shop. Step 4.3 is accomplished on-site when the vendor is installed.

### **4.1 CONFIRMING POWER AT OUTLET**

#### **4.1.1 Checking the Outlet (US and Canada)**

AMS recommends using a dedicated outlet which can supply 15 to 20 amps per vendor.

Using a volt meter set to AC VOLTS, check the voltage between the positive (smaller) lug entry and the ground lug entry (or center screw on two-lug outlets). The reading should be **between 103 volts and 126 volts**. Next, check the voltage between the negative (larger) lug entry and the ground. The reading should be **0 volts**. If your results vary, contact a qualified electrician to correct the outlet wiring before plugging in the vendor. **Abnormal voltage, reversed polarity or improper grounding may cause the vendor to malfunction or create hazardous conditions in the vendor, resulting in possible injury, damage to the vendor, or fire.**

The power cord is shipped in the hopper on the inside of the door. The cord is supplied with a standard NEMA 3-wire plug. If there are no 3-wire outlets available for powering the vendor, a grounding adapter may be used to convert a 2-wire outlet to accept the 3-wire plug. **The adapter must have a ground tab or wire which must be fastened to the center screw of the outlet.** . When the adapter is installed in the outlet recheck voltage as given above for 103 to 126 volts and also as given above for 0 volts.

#### **NEVER USE AN EXTENSION CORD WITH THE VENDOR.**

#### **4.1.2 Checking the Outlet (Outside the US and Canada)**

Consult a qualified electrician to check the outlet for proper polarity, voltage, and grounding. Check the serial plate on the side of the door to confirm the vendor is rated for the outlet voltage.

#### **4.1.3 Electrical Service Requirement for CE Compliance**

The following requirement applies only to models using ½ HP compressors and displaying the CE mark on the serial plate. If this requirement applies to your vendor, you will see a similarly worded decal on the back of the vendor near the power cord. This requirement does not apply to any vendor using 120V service.

#### **ELECTRICAL SERVICE REQUIREMENT FOR CE COMPLIANCE:**

**THIS EQUIPMENT IS INTENDED FOR USE ONLY IN PREMISES HAVING A SERVICE CURRENT CAPACITY OF AT LEAST 100A PER PHASE, SUPPLIED FROM A DISTRIBUTION NETWORK HAVING A NOMINAL**

**VOLTAGE OF 400/230V. THE USER SHOULD DETERMINE IN CONSULTATION WITH THE SUPPLY AUTHORITY, IF NECESSARY, THAT THE SERVICE CURRENT CAPACITY AT THE INTERFACE POINT IS SUFFICIENT FOR THIS EQUIPMENT.**

#### **4.1.4 Requerimiento de Servicio Eléctrico para Certificación CE**

El siguiente requerimiento se aplica solamente a los modelos utilicen compresores de ½ HP y que muestren la marca CE en la placa de serie. Si este requerimiento se aplica a su dispensadora, verá una calcomanía con una terminología parecida en la parte posterior de la dispensadora, cerca del cordón de corriente.

Este requerimiento no se aplica a dispensadoras que utilizan un servicio de 120V.

#### **REQUERIMIENTO DE SERVICIO ELECTRICO PARA CERTIFICACION CE:**

**ESTE EQUIPO SE PUEDE UTILIZAR SOLAMENTE EN ESTABLECIMIENTOS QUE CONTENGAN UNA CAPACIDAD DE CORRIENTE DE SERVICIO DE POR LO MENOS 100A POR FASE, Y SUMINISTRADOS POR UNA RED DE DISTRIBUCION QUE CONTENGA UN VOLTAJE NOMINAL DE 400/230V. EL USUARIO DEBERA CONSULTAR CON UNA AUTORIDAD DE SUMINISTRO, SI ES NECESARIO, PARA VERIFICAR QUE LA CAPACIDAD DE CORRIENTE DE SERVICIO EN EL PUNTO DE INTERFASE ES SUFICIENTE PARA ESTE EQUIPO.**

#### **4.1.5 Les Utilites Electriques Necessaire Pour Conformement Aux Regles CE**

Le suivant condition applique seulement à modèle en utilisant ½ HP compresseur et montrer le CE sur l'en série plaque. Si cette condition s'applique à votre vendeur, vous verrez un decal de même exprimé sur le dos du vendeur près du cordon d'alimentation.

Cette condition ne s'applique pas au service de 120V d'utilisation de vendeur.

#### **LES UTILITES ELECTRIQUES NECESSAIRE POUR CONFORMEMENT AUX REGLES CE:**

**CET EQUIPEMENT NE DOIT UTILISER QUE SUR LES LIEUX AVEC UNE CAPACITE DU COURANT AU MOINS 100A LA PHASE, FOURNIE A UN RESEAU DE DISTRIBUCION AVEC UN VOLTAGE NOMINAL DE 400/230V. LA PERSONNE QUI SE DETERMINER PENDANT UNE CONSULTATION AVEC L'ADMINISTRATION DU SECTEUR, S'IL FAUT, QUE LA CAPACITE DE COURANT AU POINT D'INTERFACE EST ASSEZ POUR CET EQUIPEMENT.**

## 4.2 VENDOR PREPARATION

### 4.2.1 Inspection

Inspect the vendor carefully for shipping damage prior to signing the carrier's delivery receipt. Check for dents on the top or sides of the vendor, bent legs, broken glass, or other damage on the exterior of the machine. Check the interior for components that may have been knocked loose or other damage.

### 4.2.2 Mounting and Connecting Bill Validators and Card Readers

The AMS vendor will support any NAMA-approved Multi-Drop Bus (MDB) bill validator or card reader. Please read the device manufacturer's literature before proceeding.

#### **WARNING: Always disconnect power to the control board before servicing.**

1. On the inside of the main door, locate and open the access doors on the left side. Locate the white plastic coin chute which leads from the coin slot on the front of the door. Above the coin chute are (2) metal plates, each fastened to a set of (4) threaded mounting studs which correspond to the mounting holes in the bill validator. Either set of mounting studs may be used for a bill validator or card reader. The lower mounting position is ADA approved for consumers with disabilities.
2. Remove the four nuts that retain the steel cover panel. Remove the steel cover panel, then press out the plastic cover panel in the escutcheon.
3. Refer to the manufacturer's literature for instructions on accessing the mounting holes in your device. Place the mounting holes over the threaded studs and reinstall the nuts. Some devices may require spacers, which are available from AMS (Part Number 20258).
4. Connect the wiring harness to the MDB harness from the control board. If two devices are installed, connect the second device to the validator.
5. If a coin mechanism has been previously installed, disconnect it from the control board MDB harness and connect it to the validator or second device if installed.
6. Reconnect power to the control board.

### 4.2.3 Mounting and Connecting Coin Mechanism (Changer)

The AMS vendor will support any NAMA-approved Multi-Drop Bus (MDB) Coin Mechanism. On some export models, the Mars-type Executive Mechanism is supported. Please read the coin mechanism manufacturer's literature before proceeding.

#### **Warning: Always disconnect power to the control board before servicing.**

1. On the inside of the main door, locate and open the access doors on the left side. Locate the white plastic coin chute which leads from the coin slot on the front of the door. Below the coin chute are (3) screws which correspond to slots on the back of the changer. Do not remove these screws.
2. Install the changer by placing the large round opening at the bottom of each slot over a screw head. Be

careful to hold the wiring harnesses in this area out of the way. Once each of the round openings are over the screw heads, the changer is lowered to engage the narrow portion of the slot with the shank of each screw (if the screws are short, back out each screw by ¼ turn and retry mounting the changer).

3. Tighten the mounting screws (reference manufacturer's literature).
4. Connect the wiring harness to the bill validator (if applicable) or to the MDB connector from the control board.
5. Adjust the white plastic coin chute as required to align the chute with the changer.
6. Reconnect power to the control board.

### 4.2.4 Determining Product Loading

Before putting the vendor on location, it is a good idea to determine the placement of products on the trays. Place at least one product in each helix to check for fit.

1. Remove the cardboard spacers and ties securing the trays.
2. Refer to Section 5.3 for tray vertical adjustments, and Section 5.4 for tray column configuration when configuring your vendor to suit your product.
3. Make sure the product can slide in and out of the helix easily. If the product is too snug, it may cause the helix to jam during vending. Place it in a helix with a larger opening.
4. Likewise, if the product is too loose in the helix, it may not vend properly. Use a helix with the smallest opening that will allow the product to slide in and out freely. Refer to Sections 5.6 and 5.7.
5. Place tall, narrow products in a column with a pusher bar, which is an adjustable bar used to push the product to one side of the column.
6. Make sure there is adequate clearance between the tops of the packages and the trays above when sliding the trays in and out, and when the product is being vended.
7. This is also a good time to set the position of the helix to make sure the first product is held securely in the helix. To do this, vend a product from each column. The end position of the helix will automatically be set to this position when a product is vended. The control stops the helix the instant the sensor detects a product falling in the hopper.
8. If desired, the position of the other helixes can be set manually by pulling the helix out of the motor, rotating it to the same position as the first helix, and reinserting it in the motor. Note that this position is automatically set after each vend.
9. Test vend the product and add a helix ejector if necessary. The helix ejector is a plastic device installed on the front end of the helix to kick out the product (refer to Section 5.9 Helix Ejector).

### 4.2.5 Configuring Motors

You will need to configure the motors if you have changed the arrangement or number of motors.

1. Press the mode switch on the control board (refer to Figure 3.1, or the decal inside the access door, for the location of the mode switch).

- Using the # key, scroll through the menu to "TRAY SETUP".
- Press 6 to configure the motors. If the number of motors displayed does not match the number of motors in the vendor, press 1 \* 0 to jog all the motors in the vendor.
- Watch the display, Missing motors that should be connected will be displayed.

#### 4.2.6 Installing Price Labels

After determining the product placement, install the price labels. The labels are shipped in the envelope with this manual.

- Insert the bottom edge of the label in the lower groove of the extrusion on the front of the tray.
- Carefully press in on the the label until it bows enough to snap into the top groove of the extrusion.

#### 4.2.7 Setting Prices

After product placement and installation of the price labels, set the prices into the vendor (refer to Section 6.6 Price Settings).

- To enter the service mode, press the mode switch on the control board (refer to Figure 3.1, or the decal inside the access door, for the location of the mode switch).
- Using the \* or # keys, scroll through the menu to "PRICE SETTINGS".
- Press 1.
- Enter the selection for which you want to set the price (example: 12).
- Press 9 to edit or change the price.
- Enter the price and press \* to save this price, then do one of the three things listed below:
  - To save the selection at this price press \* again.
  - Press 1 to save all the tray selections at this price.
  - Press 2 to save all the vendor selections at this price.
- The prices as set will be maintained by the vendor even if there is a power failure or if the machine is unplugged: however, prices will need to be reset if the program chip is changed or if the configuration of motors or trays is changed.
- Using the \* or # keys, scroll through the menu, or exit the service mode by pressing the mode switch or closing the vendor door.

### 4.3 ON-SITE INSTALLATION

#### 4.3.1 Remove the Shipping Boards

- Split the shipping boards by inserting a crowbar into the slots at either end.
- If necessary, lift the vendor to remove the broken boards using properly rated equipment. Do not tilt the vendor. Do not attempt to lift the vendor with a 2-wheel hand truck.

#### 4.3.2 Placing the Vendor in Location

- Place the vendor within 5 feet of the designated power outlet. The power outlet should be accessible when the

vendor is in position, and the ventilation opening in the back of the vendor must be clear of obstructions.

- Allow at least 4 inches between the wall and the back of the vendor for air circulation.
- Make sure the vendor does not block walkways or exits.
- Do not place the vendor in a location where it can be struck by vehicles.
- If there is a wall on the right side of the vendor leave 18 to 20 inches between the wall and the vendor. This should prevent the door from striking the wall when opened, and allow the trays to be pulled out.
- The vendor is designed to meet ADA guidelines for persons in wheelchairs using a parallel approach (side of wheelchair adjacent to front of vendor). Make sure there is adequate room to maneuver a wheelchair into this position in front of the vendor.

#### 4.3.3 Leveling the Vendor

For safe operation the vendor must be level.

- On the bottom of the vendor are four (4) threaded leveling legs located at the corners of the cabinet and a fifth support screw under the door. Before beginning, be sure that all five leveling legs are screwed in completely.
- With the door closed and locked, check the four main legs and adjust any leg that is not contacting the floor. Make sure the support screw under the door is all the way up and is **not** contacting the floor at this time.
- Place a level on top of the cabinet and check for horizontal from side-to-side.
- Adjust the leveling legs on the low side one turn at a time until the cabinet is level.
- Repeat the last two steps to level the vendor front-to-back.
- After the vendor is level, adjust the support screw under the door until it contacts the floor.

#### 4.3.4 False Leg Installation

##### WARNING

The False Leg helps to prevent the machine from tipping forward when the vendor door is open and one or more trays are extended. Failure to install the false leg may result in serious injury (refer to Figure 4.1).



Figure 4.1 Tip-Over Warning

**CAUTION: Wear gloves-edges may be sharp! Always wear eye protection when servicing vendor!**

**TOOLS REQUIRED:**

1/4" Nut driver or socket wrench

1. Align the holes in the top of the false leg with the 1/8" holes on the left side of the bottom of the door (refer to Figure 4.2). The closed end of the false leg should be facing forward.
2. Install screws through the holes and tighten until snug. Do not over tighten.

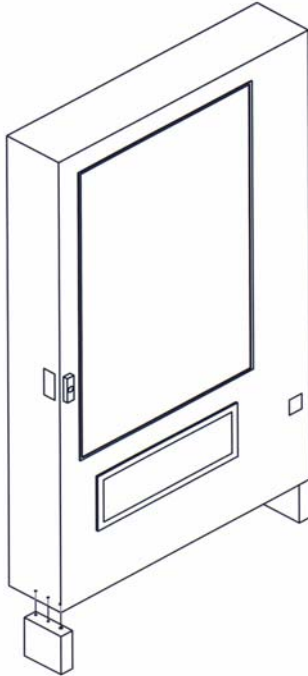

**Figure 4.2 False Leg Installation**

**4.3.5 Initial Power-Up and Cool-down**

When placing a refrigerated machine on a new location it is important to allow the machine to cool to the operating temperature **prior to placing products** in the machine. **All food products are to be packaged.** Depending upon the machine's initial temperature and ambient conditions, it will take about 4 to 5 hours to accomplish this. Normal practice is to place a machine on location and come back the next day to load it. **All food products are to be pre-frozen.**

1. Plug in the vendor.
2. Check that the lights inside the door come on: the chiller may or may not be running in its cycle at this time.
3. Enter the service mode and check that all settings are correct.
4. Check error codes for problems.
5. Load product after the vendor has cooled. Load one tray at a time, from the bottom tray up.
6. Insure vendor is operating properly. If the Health and Safety option is being used, check vendor again 75 minutes after closing door to ensure NAMA requirements are being met.

## **5.0 TRAY ADJUSTMENT AND CONFIGURATION**

The trays in AMS Sensit II vendors are highly adjustable. Practically any combination of wide and narrow columns can be set up on a tray. Before changing the configuration of your trays, make sure to order the additional parts you may need, such as new helixes, dividers and additional motors.

### **5.1 VEND TRAY**

#### **5.1.1 Removal**

1. Remove any product from the tray.
2. To remove the tray, start with the tray pushed to its rearmost position. Lift the back of the tray up and pull the tray forward about ten inches. Grasp the tray at its sides and slide the tray out. If the tray is spaced close to the tray above, it may be helpful to raise the front edge of the upper tray as you pull it free.
3. When removing a tray, it is not necessary to disconnect the tray harness. The harness is long enough that it will allow a removed tray to be placed on the floor without having to be disconnected.

#### **5.1.2 Installation**

1. To install the tray, place the tray on top of both rails and slide the tray all the way to the rear. It will automatically drop into position. Make sure the slack in the harness is draped to the outside of the right rail.

### **5.2 TRAY VERTICAL POSITIONS**

The trays can be adjusted to different vertical positions in 1 inch increments. To reposition a tray use the following steps

#### **5.2.1 Removal**

1. Remove the tray for access to the support rails.
2. Remove the safety locking screw located at the front of each rail.
3. The front of the rail can now be lifted upward and disengaged from the vertical column.
4. Pull forward to disengage the rail from the slots at the back of the cabinet.
5. Use these same steps for the other side.

#### **5.2.2 Installation**

1. To reinstall the rail in the new position, locate the new slots that will be used.
2. Push the two tabs at the back of the rail into the new slots.
3. Engage the hooked tabs at the front of the rail into the appropriate rectangular holes and pull down.
4. Make sure the rail is level.
5. Install the safety locking screw in the rail.
6. Use these same steps for the other side.

7. Reinstall the tray, making sure the harness is routed over the top of the right rail and all slack is draped to the outside of the rail.

### **5.3 TRAY COLUMN ADJUSTMENTS**

The tray columns can be configured by the user between 4 to 8 columns wide for each tray. Move the dividers, helixes, motors and harnesses to configure the tray.

Typically, each column is set to the width of a single small (2.6") or large (3.75") width helix. Single and/or double width columns can be configured in any arrangement on the tray by following the procedure below.

Plan your tray arrangement before beginning to determine which extra parts may be required. Contact your distributor to order the necessary parts.

1. Disconnect the harness and remove the tray. Place the tray on a flat, stable work surface.
2. Reposition, remove, or add tray dividers in the desired locations. To remove the divider, push rearward then lift. Reverse the procedure to reinstall.
3. It may be necessary to remove a motor and helix in order to install some dividers. Pull forward on the helix to remove it from the motor. Press down and rearward on the top motor tab to remove the motor from the tray.
4. Reposition the motors to the center of each new vend column, using the upper mounting position for the large helix and the lower position for the small helix. It may be easiest to disconnect the harness from the motors first.
5. The harness has 8 sets of motor connections. The first set of connections (at the end of the harness farthest away from the connector) is position 1, followed by 2, 3, and so on. The last set (nearest to the wire connector) is position 8. Starting at the left side of the tray, attach the harness connectors to the motors in order. For double columns, use the even numbered connection and disregard the odd numbered connection. (Example: If the first column on the left is double width, disregard position 1 and attach the connectors for position 2). Each set of connectors has a wide and a narrow connector, corresponding to a wide and a narrow tab on the back of the motor.
6. Place the correct label in front of each column, according to the motor connections used.
7. Reinstall the tray.
8. Reconnect the harness, routing it over the rail and through the back of the column.
9. After changing the tray configuration, it will be necessary to reconfigure the motor matrix. Refer to Section 4.2.6 Configuring Motors.

### **5.4 CHANGING DIVIDERS**

1. To remove, push rearward on the divider as far as it will go, then lift it up and out of the tray.
2. Reverse the removal procedure to reinstall.

### **5.5 CHANGING HELIXES**

Each helix is snapped into an adapter which snaps into the column motor.

To remove a helix from the column, grasp the helix about one "turn" away from the motor, and pull straight out sharply. Do not remove the helix adapter if the helix is going to be reinstalled.

To install a helix, insert the end of the adapter into the motor, and push the helix back towards the motor until the adapter snaps into place

### 5.6 HELIX ADAPTER

1. To remove, twist the adapter to free its locking tab from the helix.
2. Reverse the removal procedure to reinstall. The adapter is installed properly when the solid part of the adapter will push the helix in the correct direction.

### 5.7 HELIX EJECTOR

The ejector's function is to cause the product to fall sooner, and therefore stop the helix sooner. This will help retain the next product in the helix coil, especially if they are 'difficult' products

1. The helix ejector is pulled off and pressed on the helix by hand.
2. The ejector is typically positioned less than half a coil from the end of the helix.
3. The "fin" shaped portion is angled towards the front of the tray.
4. The best position and angle for the ejector is determined by vending products.

### 5.8 HELIX ALIGNMENT DEVICE

The helix alignment device is installed against the left side of the large helixes to keep them centered in their columns.

1. To remove, from the underside of the tray, use the nose of a pair of pliers to push up on the plastic mounting clips.
2. Reposition the helix alignment device on the tray. Note that the vertical part is towards the left of the mounting holes, and the flat part with the holes goes toward the helix.
3. Reinstall by pressing the plastic mounting clips into the mounting holes.

### 5.9 MOTOR POSITIONS

Motor position can be moved sideways for different columns, and there are two vertical mounting positions for each horizontal position. The lower positions are for small helixes and the upper positions are used for large helixes.

1. To remove, press down and rearward on the top mounting tab, then pull the lower mounting legs out of the mounting slots.
2. Reverse the removal procedure to reinstall.

### 5.10 AVOIDING PRODUCT HANG-UPS

Avoid large and tall products from 'hanging-up' between the tray and the glass by loading them 'left corner first' into the helix. The bottom left corner of the package should be in front of the helix to let the helix push the bottom out first (refer to Figure 5.1). An incorrect loading may cause the package to fall top first, which could lead to a hang-up. Loading 'left corner first' prevents the product from falling top first.

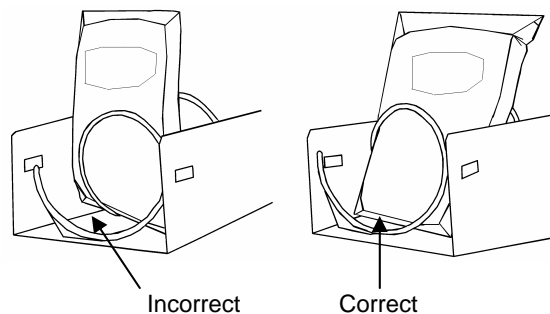

Figure 5.1 Large/Tall Product Vending

### 5.11 TALL PRODUCT VENDING

Place tall, narrow products in a column with a pusher bar. Pusher bars are installed on the dividers. Rotate the bar upward or downward to the desired position. It should hold the product upright, but not pinch or bind the product.

### 5.12 PUSHER BAR INSTALLATION

The pusher bar is an adjustable bar that mounts to the tray divider to keep tall products from falling sideways (refer to Figure 5.2). Four pusher bars are provided with the standard glass front vendor.

1. Snap the pusher bar into the retainer.
2. Rotate the pusher bar to accommodate the product.

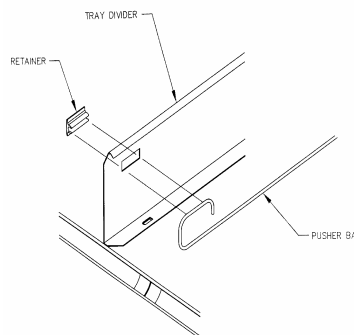

Figure 5.2 Pusher Bar Installation



## 6.0 SERVICE PROGRAMMING

### SERVICE MODE

Access the service mode by pressing the mode switch on the control board (refer to Figure 3.1). After displaying any errors, the first function is displayed. Press # or \* to scroll through the errors and functions. Return to vend mode by closing the door, pressing the mode switch or allowing the 2 minute time-out to occur.

For convenience, there is a decal on the right-hand side inside the cabinet that presents all the information in this section in a flow-chart format.

### 6.1 ERROR CODES

Any errors that have been recorded will be displayed when the mode switch is pressed. Refer to Section 7.4 for a description, along with troubleshooting tips for correcting the errors. ALWAYS CORRECT THE ERROR BEFORE CLEARING THE MESSAGE.

1. **SUBLVL ERRORS** – Displays sublevel error codes for MDB devices.
  - \***NEXT SUBLVL ERRORS** – Displays next sublevel error.
  - 0. **CLEAR ERROR** – Erases the sublevel error code from memory.
  - # **NEXT ERROR** – View the next sublevel error code.
0. **CLEAR ERROR** – Erases the error code from memory.
- # **NEXT ERROR** – View the next top level error code.

### 6.2 ACCOUNTING DATA

Limited sales information can be displayed directly on the vendor display. More detailed sales information is contained in the DEX data. This data can be collected with any DEX data collection system.

1. **HIST. VENDS** – Displays number of vends since initialization of the control board.
2. **HIST. CASH** – Displays the total sales since initialization of the control board.
3. **RESET. VENDS** – Displays the number of vends since the last reset.
4. **RESET. CASH** – Displays the total sales since the last reset.
5. **HIST. SELECTIONS** – Displays sequential number of paid vends for each individual selection since initialization of the control board. Depending on the configuration, up to 80 selections may be audited. Enter a selection by entering its characters. The display will show the total paid count for the selection for 2 seconds. At this time another selection may be entered. All selections can be accessed this way. Press # to exit to the Accounting Menu.
6. **CLEAR VALUES** – Clears RESET. VENDS and RESET. CASH.
7. **SERIAL NUMBER** – Allows programming of the serial number that will appear in field ID101 in the DEX data. The user may also choose to have this programmed

serial number used in place of the changer serial number in DEX field CA101.

8. **RESET. CARD** – Displays the total cashless sales since the last reset.

### 6.3 DATA LOGS

The user can review recorded data on vendor temperature, power outages, and door openings. This data is sometimes helpful in diagnosing problems with the vendor. These logs are cleared whenever the software is changed.

1. **TEMPERATURE** – The temperature log contains temperature measurements taken at half-hour intervals over the previous two days. The display shows the recording number, the recorded temperature, and the time and date of the recording. The log holds 96 measurements, with number 1 being the most recent.
2. **POWER** – The power outage log records power failure information. The display shows the recording number, whether power went ON or OFF, the temperature in the cabinet, and the time and date of the recording. The log holds 10 recordings, with number 1 being the most recent.
3. **DOOR SWITCH** – The door switch log records door openings and closings. The display shows the recording number, whether the door was OPENED or CLOSED, the temperature in the cabinet, and the time and date of the recording. The log holds 10 recordings, with number 1 being the most recent.

### 6.4 FILL/DISPENSE

The FILL/DISPENSE function allows the user to add coins to the changer or dispense coins from the changer.

1. **SELECT TUBE 1-5** - To dispense coins, press 1 through 5 (for a 5-tube changer) to dispense from tubes 1-5. Tubes are numbered starting with the lowest denomination. The control will display the value of the coin being dispensed and the total number of coins in that tube.
2. **OR INSERT COIN** - To fill the changer, simply drop coins in the coin slot. The display will show the value of the coin and the total number of coins in that tube. Note that coins can also be added through the back of the changer. However, the control will not be have an accurate count of the coins in the tube unless the tube is filled completely. When the high-level sensor in the tube detects coins, the control will set the correct coin count for that tube.

### 6.5 DELAYED SALES

The user can delay sales of specified selections to give the product time to settle or cool. The delay must be manually started each time sales are to be delayed.

Delayed sales has no effect on the time limits imposed by the Health and Safety rules (refer to Section 7.2). To automatically prevent sales during specific days and times, use SALES BLOCKING (refer to Section 6.10).

1. **START DELAY** – Begins the sales delay timer. Before starting the timer, choose menu item “5. EDIT SEL’NS” to specify which selections will be delayed. Customers will not be able to purchase those selections until the delay period ends.
2. **CANCEL DELAY** – Stops the delay timer and allows vending of all selections.
3. **SET DELAY** – Adjust the time of the delay timer in 15 minute increments.
4. **CLEAR ALL** – Clears all selections that were chosen to be delayed.
5. **EDIT SEL’NS** – View and change the delay status of all selections. The user can choose to apply the delay to a single selection, a tray, or all selections in the vendor.

## 6.6 TEMPERATURE

The user can set the refrigeration temperature and review the cooling performance of the vendor.

1. **CURRENT TEMP** – Displays the actual temperature in the cabinet.
2. **SETPOINT** – The user can adjust the refrigeration setpoint in 1°F increments. This is the temperature at which the refrigeration system will turn on. The refrigeration unit will turn off when the actual temperature is 4°F below the setpoint. If the vendor has Health and Safety software, and is vending perishable food, the temperature must be set to 0°F or below. A set point of -1°F is recommended.
3. **START LOG** – Begin recording the actual temperature every minute for the first 30 minutes of cooling after the door is closed.
4. **VIEW LOG** – View the temperatures recorded in the cooling log. The reading number, temperature, date and time are displayed. Press **1** or **2** to scroll up or down through the readings. This log will not display until 30 minutes after the log is started.

**TIP:** To view a temperature history of the previous 2 days, use DATA LOGS (refer to Section 6.3).

5. **HEALTH TEST** - Enabling this will cause the controller to look for any temperature above the Health & Safety setpoint. When this occurs the 15 minute HS1 timer will start, and after 15 minutes the vendor will demonstrate compliance with NAMA construction standards by going out of service. See Section 8.9.
6. **DEFROST TIME** – The interval between the defrost cycles is adjustable between 3 hours and 12 hours. More frequent defrosting may be required in more humid environments.
7. **MANUAL DEFROST** – Select this option to manually start a defrost cycle. Up to 2 defrost cycles may be manually started, one after the other, in a 30 minute period.

## 6.7 PRICE SETTINGS

Before setting prices, install a changer so that the control will recognize the proper scaling factor for your currency.

### 6.7.1 SET PRICES

Enter the tray number then the column number for the first selection to be priced. The current price for the selection will be displayed. Press **9** to edit, then enter the new price, making sure to enter all digits after the decimal point. The decimal is placed automatically based on the scaling factor from the changer.

Example: For a price of \$1.50, enter **1 5 0**.

The user can choose to apply the new price to that selection (\*\*), all selections on the tray (\*1), or all selections in the vendor (\*2). It is usually faster to set all selections to the most common price in the vendor (\*2), then change individual trays or items that have a different price.

### 6.7.2 VALUEVEND

ValueVend starts with the prices that were set using SET PRICES. Using ValueVend, any two selections may be grouped together (a matching product or a different product) and offered at a reduced price. Up to 10 such groups are available. For example, in one group, selections 23 and 33 are offered individually at full price, but if one is purchased along with the other the (total) price is reduced.

The vending machine operator should advertise the special combination prices.

1. **RESPOND TIME** is used to set the number of seconds (20 to 99) the customer has to respond before any remaining credit is returned. Set the time to at least 30 if dual languages are scrolled in the display.
  - 1 – Press to increase the seconds.
  - 2 – Press to decrease the seconds.
  - \* - Press to save the new setting.
2. **CHANGE** is used to change the settings of each group in turn, starting with Group 1.
  - GROUP** – Groups 1 through 10 may be displayed in turn by using the “\* “ key.
  - 0 CLEAR** – Clears all of the settings in the current group. Use this key before changing settings. Using CLEAR will not change prices set using SET PRICES.
  - 1 EDIT** – Enter the first selection, enter the second selection, then enter the discounted price for this grouping. Selections can be any combination of tray and column.
  - \* SAVE** – Press to save the new settings and return to the GROUP display.
  - # EXIT** – Returns to the GROUP display without saving any changes.
  - 1 EDIT** – Press to move to the price setting display. Enter a new discounted price for this group (the group selections are kept intact).
  - \* SAVE** – Press to save the new price and return to the GROUP display.

- # **EXIT** – Press to return to the GROUP display without saving any changes.
- \* **NEXT** – Display the next group.
- # **EXIT** – Return to the ValueVend menu.

## 6.8 TRAY SETUP

### 6.8.1 Test Motors

Enter the selection number to be tested, or press \* to see the following options for testing multiple motors.

- 1-JOG ALL** – All motor positions in the vendor will be tested. Each motor will be turned only a very small amount, so that products loaded in the vendor will not be dispensed. The display will show the number of the motor being jogged, or it will show a message that a motor is missing.
- 2-JOG TRAY** – All motor positions on the selected tray will be tested. The display will show the number of the motor being jogged, or it will show a message that a motor is missing.
- 3-CHECK JAMMED** – The control will attempt to run each motor that has caused a jammed motor error. The status of the motor will be displayed afterward.

### 6.8.2 Link Motors

The user can link adjacent selections of the same product on the same tray. The leftmost linked selection is the master selection. All other linked selections are vended using the selection number and price of the master selection. Linked selections are vended sequentially for better product rotation. Entering the selection number of any linked selection will default to the master selection number, and the control will vend the next linked selection in the sequence.

1. **NEW LINK** – Enter the tray where the motors are to be linked, then enter the first and last column numbers (left to right) to be linked.
2. **VIEW / EDIT** – The user can view, change, or delete existing links.
3. **CLEAR ALL** – This will delete all current links. The prices of the previously linked selections will remain the same as their master selections until new prices are set.

### 6.8.3 Delayed Stop

The user can program a delayed stop of up to one full second to allow a motor to continue running after the product has been dispensed. The delay can be incremented in tenths of a second.

1. **ENTER SELECTION** – Enter the number of the selection to be delayed, enter **9** to edit, then enter the time in tenths of a second. The decimal point is placed automatically.

Example: Entering **8** will program a delay of 0.8 seconds.

The user can save the programmed delay to the selection, the entire tray, or all selections in the vendor. Linked selections will use the delay programmed for the master selection.

### 6.8.4 Configure

The control will find all connected motors in the vendor and display the total number. The configuration of connected motors is stored in memory. If a configured motor is later found to be missing during a vend, an error message will be generated in service mode to alert the service person that the motor is disconnected.

## 6.9 MDB (MULTI-DROP BUS)

### 6.9.1 Settings

The user can select the following settings.

#### 6.9.1.1 Force Vend

The factory default is “**N**” for no. If set to “**Y**”, the customer is forced to make a selection before the control will allow a refund. If the selected product cannot be dispensed, a full refund can be returned to the customer. This setting will be over-ridden by the CHANGE BILL setting. (refer to Section 6.8.1.3).

#### 6.9.1.2 No Cheat

The factory default is “**Y**” for yes. If set to “**Y**”, the control will not allow a vend to occur unless correct change can be returned to the customer. If disabled, the control will allow the customer to be short-changed up to \$1.00.

#### 6.9.1.3 Change Bill

The factory default is “**N**” for no. If set to “**Y**”, the customer can insert a bill and receive a full refund in coins by pressing the coin return button. Note that using CHANGE BILL will override force vend.

#### 6.9.1.4 Hold Lost Credit

The factory default is “**Y**” for yes. If set to “**Y**”, any remaining credit after a vend that can't be returned to the customer will be maintained on the display for 15 minutes. The customer can add to this credit to purchase additional items.

#### 6.9.1.5 Multi-Vend

The factory default is “**N**” for no. If set to “**Y**”, the vendor will hold the change following a vend. The customer can make additional purchases with the remaining credit. The customer may push the coin return button at any time to refund this credit.

#### 6.9.1.6 Lev2 Coin Mech

The factory default is “**N**” for no. If set to “**Y**”, the vendor will treat the coin mechanism as a level 2 device. Vendor must be powered down before change will take effect. AMS recommends that this option remain as “**N**” for no.

#### 6.9.1.7 Instant Reval

Adds value to card immediately when cash is inserted.

#### 6.9.1.7.1 Bill and Cash-Less Applications

Sensit II software revision AB allowed running the vendor with no coin mech.

The changes to allow bill-only and bill and cashless applications affect fundamental MDB behavior of the VMC.

It was decided to make these changes without introducing new layers of option settings. The typical customer using a coin-based system should not notice any changes except under unusual conditions. This section will explain those changes and unusual conditions.

To simplify the discussion, the term “healthy” will be used to describe a peripheral (coin mech, bill validator, or a cashless device) which is present, which is communicating normally to the VMC, and which has no fatal out-of-service conditions.

#### 6.9.1.7.2 MDB Out-of-Service

Previously, the VMC would go out-of-service if what it determined a “critical” peripheral became unhealthy. In a coin-based system, the coin mech was the critical peripheral. In a cashless-only system, the card reader was the critical peripheral. Bill-only applications were not supported, so an unhealthy validator was never sufficient to take the machine out-of-service.

In this firmware, the machine will only go out-of-service if at first at least one peripheral becomes healthy, then all peripherals become unhealthy.

#### 6.9.1.7.3 Remaining In Service Without Coin Mech

If a bill validator is present, and the coin mech becomes unhealthy, the VMC will now continue running with the validator (and cashless if present). Over the past several years, the criteria for an “unhealthy” finding have become more stringent, as various reported error conditions such as coin jams were removed from out-of-service consideration. Right now, in practical terms, the coin mech either has to burn out completely or become disconnected to be considered unhealthy by the VMC’s criteria. A healthy coin mech going unhealthy should be a rather rare occurrence.

To help notify patrons and service personnel that the coin mech has become unhealthy, the EXACT CHANGE message will be activated. This should discourage patrons from inserting paper money, unless the prices happen to be in paper money increments. Also, patrons trying to feed coins into the mech will notice immediately that the coins disappear (in the case of a serious coin jam) or fall through.

#### 6.9.1.7.4 ‘#’ Key For Escrow Return

In bill-only applications, there is no classic coin return button to request return of the last-inserted bill. As a result, when the coin mech is considered unhealthy, the ‘#’ key will be treated as equivalent to a coin mech escrow return.

#### 6.9.1.7.5 Bill-Only Application Notes:

In a bill-only system, prices must be restricted to the scaling factor of the bill validator. Usually, this scaling factor will start from the smallest paper currency unit instead of the smallest coin unit. This will limit setting selection prices that would require change-making.

Due to the absence of a coin mech, the normal No Cheat logic is disabled, regardless of the VMC option setting. The VMC’s fairness is limited to not taking in more money than the maximum price in the machine. As

mentioned earlier, the ‘#’ key is equivalent to escrow return, possibly allowing the patron to retrieve the last-inserted bill.

The EXACT CHANGE message should never occur in a pure bill-only system.

#### 6.9.1.7.6 Bill Plus Cashless Application Notes:

Prices will be restricted to the scaling factor of the cashless device, which is usually the smallest coin unit.

Revaluation occurs in the same way it does with a coin mech, except in cases where the payment medium is at or near its maximum balance. With a coin mech, the VMC will allow credit to exceed the maximum balance as long as any excess can be paid back in coins. Without a coin mech, the VMC rejects any bills that would exceed the maximum balance (in a card-first revaluation) or rejects the payment medium entirely (in a cash-first revaluation).

## 6.10 OPTIONS

### 6.10.1 Message

The user can customize the scrolling message that is displayed when the vendor is idle. Other words can be customized by using the CREATE CUSTOM option in the LANGUAGE menu (refer to Section 6.11.3).

Write out the desired message first. The message can be up to 50 characters, including letters, numbers, punctuation and spaces. When new messages are saved the old one is erased.

Select the message option and the controller will prompt the user to press “1” to change the message, or press “#” to exit.

Tap a key (see below) to walk through a list of characters for that key. Stop at the desired character for about one second and the displayed character is moved over to the end of the new message.

Continue to select the next character. The key definitions are similar to those of telephones and cell phones:

<b>KEY 0:</b> (space)0	<b>KEY 5:</b> JKL5
<b>KEY 1:</b> !?.,\$,:*&"+/=<>=#%'1	<b>KEY 6:</b> MNO6
<b>KEY 2:</b> ABC2	<b>KEY 7:</b> PQRS7
<b>KEY 3:</b> DEF3	<b>KEY 8:</b> TUV8
<b>KEY 4:</b> GHI4	<b>KEY 9:</b> WXYZ9

Pressing the \* key will backspace through the message, removing the last character of the message. Pressing the # key will save the message (saving the message will erase the old message).

Wait several seconds to return to the options menu, or press the mode switch, to not save a new message.

The new message will be displayed when the door is closed (the old message will be displayed if a new message was not saved).

### 6.10.2 Prize

The factory default is “0” for none. The user can set the vendor to give away a free product after a predetermined number of successful vends. Enter the number of vends between free vends, up to 9999. Setting the number to “0” will disable the prize option.

### 6.10.3 Language

#### 6.10.3.1 Primary

The user is presented with a menu of available languages. The user may choose the primary language for the display of all messages. Note that Service Mode messages are available in Primary language only.

#### 6.10.3.2 Secondary

If desired, the user can select a secondary language for the display of all messages. Messages will be displayed first in the primary language, then in the secondary language.

#### 6.10.3.3 Create Custom

The user can create customized versions of words or enter words in another language. For convenience, the primary language messages can be used as a starting point. The user can then select words to modify. After creating the customized messages, set the primary or secondary language to CUSTOM.

#### 6.10.3.4 Product Sensor

If set to "Y", the vendor will use the product sensor (optional) to determine if there is product in the delivery bin. The control board will not allow vending until any product in the delivery bin is removed. A "REMOVE PRODUCT" message will be displayed. This feature is used primarily when vending products that can be damaged by other falling products.

#### 6.10.3.5 Speech

A speech synthesizer option is available for use with RC Systems Inc. DoubleTalk LT speech synthesizer. It operates only while the vendor is in service mode. The speech synthesizer vocalizes keystrokes and what is shown on the display.

Press the Options menu selection 5 enters the synthesizer on/off menu. Press 5 again to toggle on/off. Press # to exit to the Options Menu.

When turned on the synthesizer is inactive until the vendor is placed into service mode.

The synthesizer must be plugged into the DEX plug on the control board. The Sensit II utility cable (P/N 20786, Harness, Chip Programming) may be used, but it must be plugged into a male-to-male gender adapter (Radio Shack 26-231B) followed by a null modem adapter (Radio Shack 26-264). The serial cable from the DoubleTalk LT is plugged into the null modem adapter. The ¼" jack from the Sensit II utility cable is then plugged into the DEX plug on the control board (other DEX functions cannot be used while the DoubleTalk LT is plugged in). A dedicated cable could also be constructed.

### 6.11 SALES BLOCKING

The factory default is "N" for no. The user can define up to four time periods each day during which specified

selections will be blocked. For each time period, the user can select which days of the week blocking will be active. All or any combination of selections in the vendor can be blocked.

**1-4 SET PERIODS** – Enter the number (1-4) of the time period to edit. For the selected period, enter the time when sales blocking will start, then enter the time when sales blocking will end. Select the days of the week when the blocking period will be active. If a blocking period extends from one day into the next, it will be active or inactive based on the day it starts.

**ALL SELECTIONS?** - If the question 'ALL SELECTIONS?' is answered YES, every selection in the vendor will be blocked for that period as defined. If the answer is NO, then enter each individual selection where blocking is desired. Any combination of tray and column may be entered. After saving, those selections will be blocked for that period.

### 6.12 CLOCK SETTINGS

1. **TIME AND DATE** – Enter the current time and date.

This information will be used for data logs and error records.

2. **DAYLIGHT SAVINGS** – The factory default is "N" for no. If set to "Y", the time is automatically adjusted for Daylight Savings Time.

3. **DISPLAY CLOCK** – The factory default is "Y". The current time will appear on the display beneath the scrolling message when the vendor is not in use.

4. **12/24 FORMAT** – The user can choose to display the time in 12-hour or 24-hour format. The factory default is 12-hour format.

### 6.13 FREE VEND

The factory default is "N" for no. The vendor can be quickly set to vend all products for free. Prices are ignored while FREE VEND is enabled. No historical record is kept. The original prices will be restored when FREE VEND is turned off.

1. **VIEW / EDIT** – The current setting is displayed, and the user can change the setting. A warning will be briefly displayed and a double beep sounds if FREE VEND is turned on.

### 6.14 AUXILIARY OUTPUT

The auxiliary output is a 5VDC signal lasting 100 milliseconds following a successful vend. This signal can be used to trigger user-supplied external devices. As of this writing, AMS does not supply such accessory devices and cannot offer technical assistance for such devices. This feature is provided only as a convenience to those users of advanced technical skill who wish to connect such a device to their AMS vendor and have sufficient electronic expertise to do so

1. **VIEW / EDIT** – The current setting is displayed, and the user can change the setting. Enabling the auxiliary output will not harm the vendor or affect the performance of the vendor in any way.



**6.15 PROGRAM QUICK REFERENCE**

Programming instructions can also be found on the back of the vend door near the control board.

**SERVICE MODE**

- Open door and press the mode switch on the control board to enter SERVICE MODE.
- Press # or \* to scroll through the functions.
- Return to vend mode by closing the door or pressing the mode switch.

**ERROR CODES**

- 1 SUBLVL ERRORS
  - \* NEXT SUB. ERR.
  - 0 CLEAR ERROR
  - # NEXT ERROR
- 0 CLEAR ERROR
- # NEXT ERROR

**ACCOUNTING DATA**

- 1 HIST. VENDS
- 2 HIST. CASH
- 3 RESET VENDS
- 4 RESET CASH
- 5 HIST. SELECTIONS
- 6 CLEAR VALUES
- 7 SERIAL NUMBER

**FILL/DISPENSE**

- SELECT TUBE 1-5
- OR INSERT COIN

**DELAYED SALES**

- 1 START DELAY
- 2 CANCEL DELAY
- 3 SET DELAY
- 4 CLEAR ALL
- 5 EDIT SEL'NS

**TEMPERATURE**

- 1 CURRENT TEMP
- 2 SETPOINT
- 3 START LOG
- 4 VIEW LOG

**PRICE SETTINGS**

- 1 SET PRICES
- 2 VALUEVEND

**TRAY SETUP**

- 1 TEST MOTORS
  - ENTER SELECTION OR \* FOR MULTIPLE
- 2 LINK MOTORS
  - 1 NEW LINK
  - 2 VIEW / EDIT
  - 3 CLEAR ALL
- 3 HOME SWITCH
- 4 DELAYED STOP ENTER SELECTION
- 5 LETTER / NUMBER
- 6 CONFIGURE

**MDB SETTINGS**

- 1 FORCE VEND
- 2 NO CHEAT
- 3 CHANGE BILL
- 4 HOLD LOST CREDIT
- 5 MULTI-VEND
- 6 LEVEL2 COIN MECH.

**OPTIONS**

- 1 MESSAGE
- 2 PRIZE
- 3 LANGUAGE
  - 1 PRIMARY
  - 2 SECONDARY
  - 3 CREATE CUSTOM
- 4 PRODUCT SENSOR
- 5 SPEECH.

**SALES BLOCKING**

- 1 - 4 SET PERIODS

**CLOCK SETTINGS**

- 1 TIME AND DATE
- 2 DAYLIGHT SAVINGS
- 3 DISPLAY CLOCK
- 4 12/24 FORMAT

**FREE VEND**

- 1 VIEW / EDIT

**AUXILIARY OUTPUT**

- 1 VIEW / EDIT

**DATA LOGS**

- 1 TEMPERATURE
- 2 POWER
- 3 DOOR SWITCH

**ENERGYSENSIT**

- 1 ENABLE
- 2 CLEAR HISTORY
- 3 SET TEMP CHG
- 4 SET PATT TIME
- 5 SET HIST FACT
- 6 SET DEL TIME
- 7 LIGHTING





## 7.0 TROUBLESHOOTING

### 7.1 OUT OF SERVICE MESSAGE

Certain critical errors will disable the vendor. When this happens, an "OUT OF SERVICE" message will be displayed. If the error is related to the Health and Safety function the "OUT OF SERVICE" message will be followed by an error code beginning with "HS." Refer to the section on Health and Safety errors below.

**Please note that if a Health and Safety error occurs, any food which may have spoiled should be discarded.**

To get the vendor back in service, press the mode switch on the control board. Any errors will be displayed immediately. Refer to the list of error codes and explanations below. Correct the cause of the error, and press "0" to clear the error code.

If the error code was generated by an MDB device (CHANGER, BILL VALIDATOR, or CARD READER), press 1 to see more detailed (sublevel) error codes.

### 7.2 HEALTH AND SAFETY ERRORS

NAMA specifications for frozen food require that the temperature in the vendor must cool to 0°F within 75 minutes, and 25°F for slacked food within 75 minutes, of closing the door (note that Delayed Sales has no effect on this cool-down period). This is to allow a recovery period following loading. **ALL PRODUCTS MUST BE FROZEN PRIOR TO LOADING.**

After this requirement has been met, the temperature in the vendor must never get above 0°F (or for slacked foods 25°F) for more than 15 minutes.

For vendors having this software, the H&S function is activated automatically when certain temperatures are set. See the following chart. Unless otherwise specified by regulatory agencies, AMS recommends setting the temperature 1 degree colder than the recommended temperature.

In the event the internal temperature exceeds the NAMA specifications following the recovery period or during normal operation, an error will be generated and the vendor will not allow further sales. This protects the consumer from purchasing spoiled product. H&S error codes are detailed in Section 7.3.

See the following table for the capabilities of your vendor:

FFV (FROZEN FOOD VENDOR)		
CAPABILITY	TEMPURATURE	PROTECTION
SNACK	75°F TO 41°F (24°C TO 5°C)	NONE
REFRIGERATED FOOD	41°F OR COLDER (5°C)	H&S
SLACKED FOOD	25°F OR COLDER (-4°C)	H&S
FROZEN FOOD	0°F OR COLDER (-18°C)	H&S

The H&S function can be tested to see if it is operating properly by simulating a temperature sensor failure. Refer to the next section for testing the Temperature System (H&S).

### 7.3 MACHINE ERROR CODES: CAUSES AND SOLUTIONS

#### 7.3.1 Viewing Top Level Error Codes

To view top level error codes, enter the service mode by pressing the mode switch located at the lower right corner of the control board. **ACCT DATA** will be displayed if there are no errors or an error has been cleared (whether corrected or not). If the error message has been cleared, but the cause has not been corrected, the message can be re-displayed by briefly turning off the power. Use the keypad buttons to perform the following:

**#. NEXT ERROR** – to view the next top level error code in memory.

**1. SUBLVL ERRORS** – to display any sublevel error codes including MDB devices.

**0. CLEAR ERROR** – to erase the error code from memory (first correct the error).

#### 7.3.2 Viewing Sub-Level Error Codes

To view the sub-level error codes, press the 1 key while the top level error code is being displayed. Correct the condition which caused the error first, then clear the error code by pressing "0". Once all errors are cleared, "ACCT-DATA" will be displayed. Refer to the next section for a description of error codes, their causes and solutions.

7.3.3 Error Code Chart: Causes and Solutions

ERROR CODES – CAUSES AND SOLUTIONS			
Top Level Error Code	Sub Level Code	Causes	Solutions
<b>JAMMED</b>	XX JAM	Jammed product in helix, broken/jammed helix adapter, helix caught on tray or divider, “frozen” motor or broken gearbox	Remove any jammed products and test the motor using TRAY SETUP in the service mode. Refer to Section 7.5
	ALL OK		
	XX OK		
<b>OUT OF SERVICE HS1</b>	NONE	The internal temperature rose above the setpoint for 15 minutes.	The power was disconnected, the door was not closed completely, or the refrigeration system needs service/cleaning. Check/clean screens. Check operation of door switch. Check DATA LOGS in service mode for more information.

<b>OUT OF SERVICE HS2</b>	NONE	The internal temperature did not reach the setpoint within the time limit after closing the door.	The door was open too long, warm product was loaded, the door was not closed completely, power was out, or the refrigeration system needs service/cleaning. Check/clean screens. Check data logs in service mode for more information.
<b>OUT OF SERVICE HS3</b>	NONE	The door switch was open more than 30 minutes.	The door was not closed properly or there is moisture inside the door switch. If proper operation is not restored by closing the door, replace the door switch.
<b>BUTTON X STUCK</b>	NONE	Keypad selection button X has been depressed more than 2 minutes.	Clear any obstructions or dirt from around the selection buttons and make sure they can move freely. If proper operation is not restored, replace the keypad.
<b>CHANGER</b>	A message has been generated by the changer. Press 1 to see changer sub-level error codes.		
	COMMUN	COMMUNICATIONS – Communications error.	Check MDB harness connections.
	SENSOR	SENSOR – Sensor error.	Consult changer manual or manufacturer.
	JAM TUBE	JAMMED TUBE – Jammed coin tube.	Clear any obstructions from the coin tube.
	CHK SUM	CHECK SUM – Check sum error.	Consult changer manual or manufacturer.
	CHUTE	CHUTE – No coins accepted for a period of time.	Clear any obstructions from the coin chute.
<b>BILL VALIDATOR</b>	A message has been generated by the bill validator. Press 1 for bill validator sub-level error codes.		
	COMMUN	COMMUNICATIONS – Communications error.	Check MDB harness connections.
	STK FULL	STACKER FULL – Stacker is full.	Empty stacker.
	MOTOR	MOTOR – Bad stacker motor.	Consult acceptor manual or manufacturer for repair.
	JAM BILL	JAMMED BILL - Bill is jammed.	Clear any jammed bills from the acceptor.
	CHK SUM	CHECK SUM – Check sum error.	Consult acceptor manual or manufacturer.
	OPEN BOX	OPEN BOX – Open box.	Close the bill box.
	SENSOR	SENSOR – Sensor error.	Consult acceptor manual or manufacturer.

7.3.3 Error Codes: Causes and Solutions (Continued)

Top Level Error Code	Sub Level Code	Causes	Solutions
CARD READER	A message has been generated by the card reader. Press <b>1</b> to see sub-level error codes.		
	CARD ERROR -.	Card error	Use a different card.
	INVALID CARD –	Invalid card	Use a different card.
	TAMPER	Tamper error.	Consult card reader manual or manufacture.
	COMMUNICATIONS 4	Communications error.	Check MDB harness connections.
	SERVICE	Unit needs service.	Consult card reader manual or manufacturer.
	READ ERROR	Reader failure.	Consult card reader manual or manufacturer.
	COMMUNICATIONS 9	Communications error	Check MDB harness connections.
JAMMED CARD	Card is jammed.	Clear the jammed card from the card reader.	
PROD. SENSOR	NONE	The product sensor is blocked or disconnected.	Remove any products or other objects in the bottom, or in sensor openings in ends of the delivery bin. Check sensor harness connections.
SENSIT BLOCKED	NONE	The vend sensor is blocked or lens is fogged.	Remove any obstructions from the path of the sensor.
SENSIT DISCONN'D	NONE	The vend sensor is disconnected.	Check all sensor harness connections.
SLIDE DOOR STUCK	NONE	The sliding door will not open or close.	Remove ice buildup (look for air leaks).
			Reconnect loose motor wire (look for damage to motor harness).
			Remove jammed product (look on sides and behind sliding door).
FFIB DISCONN'D	NONE	Indicates a communication problem with the interface board (FFV) inside the right rail mount.	Check harnesses connecting interface board and primary sensor board with control board.

7.4 CLEARING JAMMED MOTOR

If one or more motors and helixes become jammed, the motor(s) will be displayed as a sublevel error under "Motor Jammed".

**Energized vend motors can turn a helix with considerable torque, creating a possible entrapment hazard. Disconnect power to the vendor or control board before freeing a jammed helix or motor.** Always restrain or block the helix before freeing a jammed or caught product.

**CAUTION: Use caution when freeing jammed product! Refer to 2.2.4 Helix Motion and Jamming!**

Clear any jammed products from the indicated vend columns.

To reset the error, first enter service mode (refer to Section 6.0), then select Tray Setup (refer to Section 6.7.1). Press "1", then "\*" , then "3". The control will attempt to run the jammed motors. If the motor had been taken out of the motor matrix, it will be re-established in the matrix.

7.5 ICE FORMATION IN THE CABINET

Ice formation in the cabinet indicates an air leak which allows moist air to continually enter the cabinet and condense near the leak.

1. Make sure the seal around the sliding door mates completely with the cabinet door and wedge shapes on each side.
2. Make sure the vendor door is properly tightened so that it makes contact with the gasket on all sides.
3. Make sure there are no foreign objects interfering with the vend door, and the vend door closes properly.

7.6 MACHINE TROUBLE SHOOTING CHART

The following troubleshooting chart may be used to find quick remedies for electrical and mechanical failures in the vendor.

## 7.6 MACHINE TROUBLE SHOOTING CHART

**IF A REPLACEMENT PART IS NECESSARY, PLEASE CONTACT YOUR DISTRIBUTOR**

Symptom	Possible Cause	Remedy
No power at the control board. (no beeping sound during power-up or when the service mode button is pushed)	No power from power cord.	Check power cord, outlet or supply.
	3.0 amp fuse is blown.	Replace 3.0 amp fuse.
	Fuse harness is not connected to the back of the fuse holder.	Connect fuse holder harness.
	Power harness is disconnected.	Reconnect power harness.
	Short or cut in the power harness between the transformer and control board	Check continuity through the power harness. If there is no continuity replace the power harness.
Vendor displays "Please Make Another Selection".	Transformer does not have power at the 24 VAC secondary side.	Insure primary side of transformer is receiving power. If there is no 24 VAC on secondary side replace transformer.
	Selection not configured in the motor matrix.	Reconfigure the motors.
	Motor jammed	Clear jammed motor and clear error code
Vendor does not accept coins.	Vend not sensed by sensor	Clear fault in sensor boards or harness: possible control board error
	Options set for "Free Vend"	Scroll to Free Vend and change to <b>N</b>
	Changer unplugged.	Plug in changer.
	Coins jammed.	Clear jammed coins.
	Defective changer or other MDB device.	Replace changer.
	Credit amount exceeds the highest price. (Prices may be set at \$0.00.)	Set prices.
Vendor will not pay out coins.	Control board is in service mode.	Exit service mode.
	Changer unplugged.	Plug in changer.
	Defective changer.	Replace changer.
	Coins jammed.	Clear jammed coins.
Validator will not accept bills.	No coins in changer.	Add coins to the changer.
	Changer unplugged.	Plug in changer.
	Not enough change in the changer.	Add coins to the changer.
Bill is immediately stacked.	Validator unplugged.	Plug in the validator.
	Change feature is enabled.	Disable change feature.
	Highest price is greater than bill value.	Change price.
Tray selections do not make a complete cycle.	Non configured selection has a price greater than bill value.	Set and save all prices, including selection columns not in use.
	Harness off at the J-1, J-5 and/or J-6 connector on the control board.	Connect harness to the control board connector. Check harnesses.
Health and Safety shut down.	Door switch is not working.	Adjust switch for positive contact with door.
		Close door tightly.
		Replace defective door switch.
		Replace defective door switch harness.
	Evaporator frozen.	Check for air leaks.
		Check for a failed evaporator fan motor. If it has failed replace the evaporator fan motor.
		Check evaporator fan switch harness connection.
Replace evaporator switch.		
Defective temperature sensor.	Replace temperature sensor	
Refrigeration problem.	See below.	

## 7.6 MACHINE TROUBLE SHOOTING CHART (CONTINUED)

***IF A REPLACEMENT PART IS NECESSARY, PLEASE CONTACT YOUR DISTRIBUTOR***

Symptom	Possible Cause	Remedy	
Refrigeration unit not running.	No Power	No power at outlet/Tripped circuit breaker	
	Door switch is not working.		Adjust switch for positive contact with door.
			Close door tightly.
			Check door switch harness connection.
			Replace defective door switch.
			Replace defective door switch harness.
	Temperature setting in the control board is set too high.	Reset temperature setting.	
	Refrigeration relay harness disconnected.	Connect refrigeration relay harness.	
	Inoperative Relay	Check for low voltage and high voltage.	
	Defective refrigeration relay.	Replace relay.	
	Over-pressure timer.	Allow 15 seconds for system pressure to equalize, then try again.	
	Blocked air flow		Clean ventilation screen
			Replace filter
		Clean condenser coils	
Compressor overheated		Allow 1 hour for compressor to cool, then try again	
		Defective overload	
		Low line voltage (below 103VAC)	
Refrigeration unit runs constantly	Temperature sensor defective	Replace	
	Lost communication	At primary board/control board or interface board.	
	Defective chiller relay	Replace	
	Refrigerant has been lost	Seal leak and replace	
	Major air leak in cabinet	Find and repair air leaks	



## 8.0 MAINTENANCE

### 8.1 REPLACING THE PROGRAM CHIP

Occasionally it may be necessary to replace the program chip to take advantage of new software features. Please note that after replacing the chip it will be necessary to reprogram prices and any other variables such as option settings and blocking times that have been changed from the factory settings. The motors will need to be reconfigured. The Product Sensor option, if used, will need to be set to "Y", and if the 1.5" Helix Tray is installed the home switch (in tray setup) will need to be set to "N".

1. Disconnect the power to the control board by using the power switch located on the right rail mount above the refrigeration unit power outlet.
2. Locate the program chip (refer to Figure 8.1).
3. Insert a chip removal tool in one of the slots located at the corners of the socket and pry the chip from the socket. Note that the chip has one chamfered corner which corresponds to a chamfer in the socket.
4. Press the new chip in place, making sure the chamfer is correctly oriented and the wires on the chip line up with the connections in the socket.
5. Reconnect the power to the board and check the software revision number, which is briefly displayed for several seconds after connecting the power.
6. Configure the motors, program the prices and re-enter any other desired settings. Refer to Section 6.0, Service Programming.

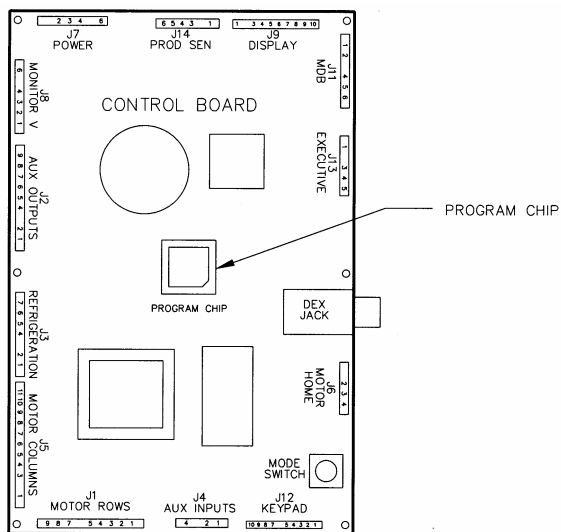

Figure 8.1 Replacing Program Chip

### 8.2 CLEANING THE REFRIGERATION UNIT AND SCREENS

AMS recommends cleaning the refrigeration unit and screens at least twice a year under normal conditions, more often in dusty environments.

**CAUTION: Always wear eye protection and gloves when cleaning vendor! Condenser fins are sharp!**

1. Unplug the vendor.
2. Remove the cover and the filter. If the filter is disposable discard it.
3. Remove dust from the condenser fins and coils with a vacuum or stiff brush.
4. Remove dust from the outside of the rear screen.
5. Remove dust from the inside and outside of the bottom screen.
6. Install a new filter.
7. Replace the cover.
8. Plug in the vendor.

### 8.3 CLEANING THE VENDOR CABINET

Clean the vendor cabinet as necessary using mild household cleaners and water. Apply the cleaning solution to a cloth or sponge and gently wipe the vendor surfaces to clean.

1. Do not use chemicals or solvents. These can damage the paint and plastic trim.
2. Do not use abrasive cleaners.
3. Do not use a water jet.
4. Do not let water or cleaning solutions contact electrical or electronic components.
5. Clean the glass front inside and out with a good window cleaner.

### 8.4 CLEANING THE PLASTIC DOOR LINER

The door liner is made from an ABS plastic. This liner should be cleaned with a mild detergent diluted in water. Do not use chemical solvents or harsh detergents as these products could crack the liner.

### 8.5 CLEANING THE GLASS WINDOW

The inside window is a triple-pane sealed glass window. The outer window is a single tempered glass pane. The inside window is hinged to allow easy cleaning.

1. Open the vendor door.
2. Operate the latch, mounted inside the vendor door, which secures the inside window. When released the inside window can be swung open on its hinges.
3. Clean both sides of both windows with any good glass cleaner.
4. Use a soft cloth, a squeegee and/or chamois. Do not use any solvents, chemical or abrasive cleaners on the glass.
5. Close and latch the inside window, then close the vendor door.

### 8.6 LUBRICATION WITH LITHIUM GREASE

Once a year the door moving parts should be lubricated with grease.

1. Apply grease (or similar lubricant) to the door lock bolt threads and the door hinges as necessary.
2. Wipe off excess grease.

No other lubrication is required.

### 8.7 REPLACING FLOURESCENT BULBS

1. Unplug the vendor from the wall.
2. Open the door.
3. Open the glass window.
4. Turn defective bulb one-quarter turn and, at both ends at the same time, slide out through the slots in bulb sockets.
5. Dispose of defective bulb properly.
6. Install the new bulb by inserting bulb pins at both ends at the same time through slots in bulb sockets, then turn bulb one-quarter turn.
7. Plug in the vendor to test the lamps.
8. Close the glass window.
9. Close the vendor door.

### 8.8 DEFROSTING THE EVAPORATOR COIL

Excess moisture accumulating inside the cabinet may freeze in the evaporator coil. As the coil becomes blocked all useful chilled air is also blocked.

1. Leave the vendor plugged in.
2. Open the door.
3. If the vendor has entered an H&S vending hold, the products should be disposed of.
4. In Service Mode, select TEMPERATURE, then select MANUAL DEFROST – Select this option to manually start a defrost cycle. A defrost cycle will last about 14 minutes. Up to 2 defrost cycles may be manually started, one after the other, in a 30 minute period.
5. While the defrost cycle is on, check that the bulkhead around the bottom of the refrigerated section of the cabinet is securely mounted to the cabinet and is sealed on all sides.
6. Check that the gasket on all sides of the sliding door on top of the bulkhead is intact, and that the front gasket seals against the vendor door.
7. Check the door gasket around the cabinet opening. It should be intact.
8. The gaskets must seat against the flat part of the door without obstructions.
9. Check to see if the door closes squarely on all four sides and the lock draws the door firmly against the gasket.
10. Any physical problems must be corrected. If the environment is humid or has become more humid (as in a seasonal change), then shorten the defrost time.
11. In Service Mode, select TEMPERATURE, then select DEFROST TIME. The interval between the defrost cycles is adjustable between 3 hours and 12 hours. More frequent defrosting may be required in more humid environments.

12. Close the door.
13. Allow to cool down before reloading frozen products.

### 8.9 TESTING THE TEMPERATURE SYSTEM (Health and Safety)

1. Enter the service mode (refer to Section 6.0).
2. Press # until the Temperature section appears, then press 2 to view the current set point. The temperature will be displayed in both Fahrenheit and Celsius.
3. At this point temporarily disconnected the sensor, causing the controller to assume a temperature of 120°F/49C.
4. In the Temperature Section, in service mode, press 5.
5. Close the door and wait 15 minutes. At this point the display should read “OUT OF SERVICE – HS1”.
6. Reconnect the temperature sensor harness.
8. Close vendor door. The vendor will return to normal operation (including a cool-down time if needed).

### 8.10 PC UTILITY LOADING INSTRUCTIONS

An AMS vendor designed for vending food meets or exceeds standards for Health and Safety (H&S), and H&S software must be used. A vendor not designed for H&S may have H&S software installed but it will not meet H&S requirements.

These instructions are for loading of Sensit II software into the vendor, configuring the vendor software as required, and/or downloading of selected history files.

The configuration settings can be saved in a file for configuring the vendor again at a later time, or for uploading the same configurations to other vendors.

#### 8.10.1 Requirements

The basic application requirements are:

1. An IBM compatible PC (a lap-top or similar PC) operating on Windows 98 or higher.
2. 32MB RAM (64 recommended).
3. VGA monitor or better.
4. CD-ROM drive.
5. DB9 Serial port, or USB adapter.
6. CD from AMS containing the most current version of P/N 3302, AMS Sensit II Utility and the most current vendor software for your application.
7. P/N 20786, Harness, Chip Programming (See Figure 8.2 at the end of this section of the manual).

#### 8.10.2 Installation

Install software onto the PC as follows:

1. Turn on the PC.
2. Use the “Add/Remove Programs” feature in Control Panel to remove any previous versions of the Sensit II Utility before loading the new version.
3. Place the AMS Software CD in the CD drive.
4. If the CD-ROM does not start automatically, choose START, then RUN, then type D:\setup.exe (where D is the name of your CD-ROM drive).
5. Follow the on-screen instructions of the installation guide.



- After installation, the AMS software may be left on the PC. Store the CD as a backup.

### 8.10.3 Startup

After loading of software into the PC, start up in the following order:

- Connect the cable connector to the PC serial port (leave the ¼" plug unplugged at this time, see Figure 8.2).
- Turn on the PC
- Turn on the vendor.
- To open the program, double-click on the desktop icon placed there during installation.
- After the program has opened (and the vendor is running), plug the ¼" plug into the jack on the side of the control board in the vendor.
- Further choices are described below.

### 8.10.4 Toolbar

The AMS Utility tool bar is located in the upper left hand of the screen

**FILE:** Provides typical Windows-type options such as NEW, OPEN, SAVE, PRINTER/SETUP, and EXIT.

**COMM:** Use to select what type of task to perform using the AMS Utility software:

**RECEIVE CONFIGURATON** is used to download settings from a vendor to save for future use.

**SEND CONFIGURATION** is used to upload new settings to a vendor.

**RECEIVE DATA LOGS** is used to retrieve four data logs (Power, Door, Temperature, and Cooling). Collected data will be displayed in the Data Logs block.

**NOTE** The cooling log must be active for 30 minutes before cooling data is available.

**RECEIVE AUDIT** is used to collect standard information. Collected data will be displayed in the Audit Data block.

**SEND FLASH** is used to update the software used by the vendor control board (electronic transfer of the software eliminates the need to replace chips)

**RECEIVE FLASH** is used to download the software used by the vendor control board for other uses (electronic transfer of the software eliminates handling chips).

**TOOLS:** Primarily used during the initial startup to determine if the serial cable is connected to the correct COMM port. You may also un-synchronize the settings clock with the internal clock in your computer, but this is normally enabled.

### 8.10.5 Program Screens

The AMS Utility programs are located in a column on the left side of the screen.

**PRODUCT INFO:** This screen allows selections and entries to be made at an individual product level.

**SELECTION ID:** Identifies the tray and column.

**PRODUCT NAME:** This feature is not available through the vendor keypad. Up to a 16 digit entry in this field will be briefly shown on the display when this selection is made on the

vendor. An example entry may be "Ice Cold" when a soda has been selected.

**PRICE:** The maximum price is \$199.95 for US applications (or 3999 base units if referencing the scale factor). It should be a multiple of the lowest denomination coin used, but if not, the control will round up to the next highest price that can be represented exactly.

**DELAY SALE** is enabled here for each product.

This must be turned on and in the SETTINGS screen an enable box checked and the delay time specified in order for Delay sales to occur.

**DELAYED STOP** can be set for up to one second, in 0.1 second intervals, allowing a vend motor to continue running after the product has been dispensed.

**SETTINGS:** This screen provides for turning some features on and off and for entering messages and data:

**GENERAL VEND:** These options are more fully explained elsewhere in the manual. Please note these features:

**NO-CHEAT** and **HOLD LOST CREDIT** are enabled by default. The **PRIZE** box default is zero. If your vendor is so equipped, turn on the **PRODUCT SENSOR** using the **ENABLE** box.

**LANGUAGE:** Service mode will be displayed in the primary language only. Customer messages will scroll the primary language first, followed by the secondary.

**MISCELLANEOUS:** The chiller temperature setpoint (when the chiller will run) is adjusted here.

**NOTE:** AMS recommends an H&S setpoint of 40° for vendors which are vending perishable food.

**MACHINE S/N** The customer may enter any desired serial number in 'Machine S/N'. Checking the 'Use for changer SN' box will make the coin mechanism serial number match the machine.

**DELAY SALES:** Must also be enabled and the time delay entered here in order to delay sales for the items selected at the Product Info screen.

**CLOCK/CALENDAR:** If not current, reset the time and day/month/year.

**ENERGYSENSIT:** Settings for the power savings program for refrigeration and lighting may be made here, and the two programs turned on and off.

**NOTE:** Setting the chiller setpoint to 40°F enables H&S and will disable the refrigeration power saving selection. The lighting power saving feature is not affected.

**USER MESSAGE:** may be up to 50 characters, including lower case and additional punctuation marks not available through the keypad.

**BLOCKING:** This screen displays four periods during the day when sales will be disabled (Note that Sales Blocking and Delay Sales are used for different purposes). For each period select the start time, end time and day of the week. Then select any number of tray and column combinations to block in that period. The default is all selections are blocked.

- TRAY:** This screen provides a way to “link” motors for space-to-sales applications.
- MASTER/LINKED:** Check ‘Master’ for the left-most selection, and ‘Linked’ for as many as desired directly to the right of the Master. Linked selections are vended sequentially for better product rotation. Whatever price is set for the Master will be used for any linked motors.
- HOME SWITCH:** Enable the Home Switch for the older Gum & Mint trays that use a switched vend motor. If the vendor is equipped with 1.5” helix trays, these should be disabled.
- VALUEVEND:** This screen displays response time (default of 30 seconds), two product selections in each of 10 groups, and a total price. In any group, change the price then select any product button to display the assignment chart. Select the two products to be grouped for that price. Select APPLY to enter this group into the ValuVend program and return to the first screen to allow making additional selections.
- DATA LOGS:** The screen is used to view and print the four logs (Power, Door, Temperature, and Cooling). In order to view the first three, select Comm|Receive Data Logs at the ToolBar. Print a log by right-clicking anywhere in the data, then select ‘Print Log’.
- AUDIT DATA:** This screen displays the standard information stored in the controller. To access this data, select Comm|Receive Audit. Accessing this information will reset the resettable counters, and will register in the EA\_ field, which is a history of reads.

**8.10.6 Software Operation**

To upload to the vendor:

1. Go through all the screens and configure all settings and entries as desired.
2. Save the completed configurations.
3. Select SEND FLASH.
4. A message will come up on the screen asking “Would you like to preserve current configuration?” Selecting “YES” will maintain all the pricing, messages, ect. currently on the vendor. Selecting “NO” will upload the new configuration data to the vendor. The upload will start automatically.
5. In a few minutes the upload will be complete.

**8.10.7 Shutdown**

After loading of software into the PC or the vendor, configuring the vendor software as required, or downloading of selected history files, shut down in the following order:

1. Save the configuration file for future use.
2. Unplug the cable from the vendor control board.
3. Unplug the vendor.
4. The AMS Sensit II Utility may be left on the PC as convenient.
5. Change to other programs or shut off the PC as desired.

**NOTE:** Different or special configuration files can be made up and saved for future use.

**NOTE:** The method of startup and shutdown can be modified to allow changing the software and configuration in multiple vendors.

**8.10.8 Errors**

This software has been tested on Windows platforms from 98se to XP. However, should errors occur, the lower left corner displays the current error and can help eliminate problems.

- “BOOT LOAD 1.22” is displayed when the vendor is powered up while connected to the PC running this software. Disconnect power to the vendor, unplug the cable and restart the vendor.
- “UNEXPECTED APPLICATION RUNTIME ERROR...DESCRIPTION: PORT ALREADY OPEN” occurs when this software is started while connected to the vendor, the cable is connected to the wrong serial port, or the PC is looking in the wrong place. Go to Tools|Preferences|Comm Settings and select a different port. Then restart.
- “NO RESPONSE TO ENQ” occurs when there is no connection at one end of the cable. Usually this occurs when the plug is not pressed fully into the jack, there is a bad connection within the plug, there is a broken wire in the cable, or the cable is connected to the wrong serial port.

**NOTES:**  
 1. USE HARNESS BETWEEN DEX JACK ON CONTROL BOARD AND PC.  
 2. THE HARNESS IS NOT REQUIRED TO BE SHIELDED.  
 3. USE ROBIN-CORE SOLDER FOR SOLDER JOINTS.

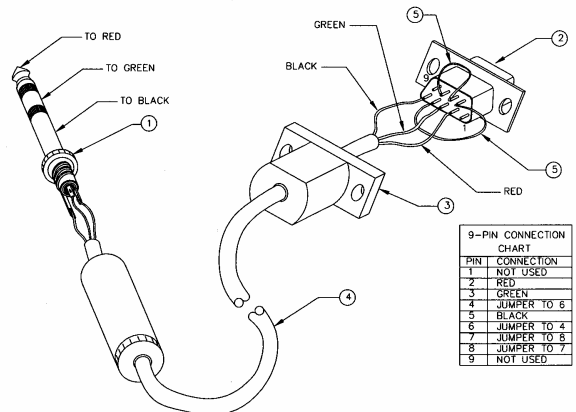

INDEX	PART DESCRIPTION	QTY	SOURCE SUGGESTION *
1	1/4" 3-CONDUCTOR PHONE PLUG	1	RADIO SHACK 274-1546 (SHIELDED) OR RADIO SHACK 274-139 (NON-SHIELDED)
2	9-PIN "D" FEMALE CONNECTOR	1	RADIO SHACK 276-1538 (SOLDER)
3	9-PIN "D" CONNECTOR HOOD	1	RADIO SHACK 276-1508 (METAL) OR RADIO SHACK 276-1539 (NON-SHIELDED)
4	3-CONDUCTOR SHIELDED CABLE, 6 FT.	1	BELDEN M 9534 CMG 4C24 (UL) E108998 (SHIELDED) OR PHILATHANE ES-243-10 (COILED ELECTRONIC CABLE, SHIELDED)
5	24 Ga INSULATED HOOKUP WIRE, 1.5"	2	HOOKUP/BREADBOARD WIRE

\* ANY SIMILAR PART OR SOURCE MAY BE USED.

DRAWING BASED ON 20786, HARNESS, CHIP PROGRAMMING

**Figure 8.2 Harness, Chip Programming**

**8.11 REPLACING THE POWER CORD**

**TOOLS REQUIRED:**

Use this procedure to replace a power cord that is cut, split open or is otherwise damaged or is a hazard. A ¼” nut driver, gloves and protective eyewear are required.

**REMOVAL**

1. Move the vendor away from the wall and unplug the power cord from the wall outlet.
2. Remove and save the 6 screws attaching the cover. (refer to Figure 8.3).
3. Unplug the power cord from the vendor as the protective cover is removed.
4. Operate the small lever on the wire tie to open the wire tie loop and free the power cord.

## INSTALL

1. Plug the new power cord into the vendor's IEC receptacle but do not plug into a wall outlet at this time.
2. Place the cover over the power cord and the IEC receptacle (refer to Figure 8.3), with the open side to the left as shown. The cover will help prevent the power cord from being removed.
3. Align the holes in the cover with the holes on the back of the machine. Reinstall 6 screws through the holes in the cover. Do not over-tighten the screws.
4. Fold the cord once. Loop the wire tie around the fold and tighten it.
5. Install the wire tie and attached power cord, by inserting the locking tab into the hole in the cover.
6. Plug the power cord into the power outlet. The power should come on in the vendor.
7. If the power is on in the vendor, test the GFCI as follows: press the TEST pushbutton on the GFCI for 1 second to trip the GFCI and shut it off. The vendor power should turn off. Then press the RESET pushbutton for 1 second to return the GFCI to normal operation. The vendor should turn on.
8. If the power is not on in the vendor check the GFCI as follows: press the TEST pushbutton on the GFCI for 1 second to trip the GFCI and shut it off. Then press the RESET pushbutton for 1 second to return the GFCI to normal operation. The vendor should turn on.
9. If there is no power, check the power outlet at the wall. If there is power at the outlet check for power at the plug end of the power cord. Refer to the operation and maintenance manual troubleshooting section.
10. If everything is operational return the vendor to its position next to the wall.

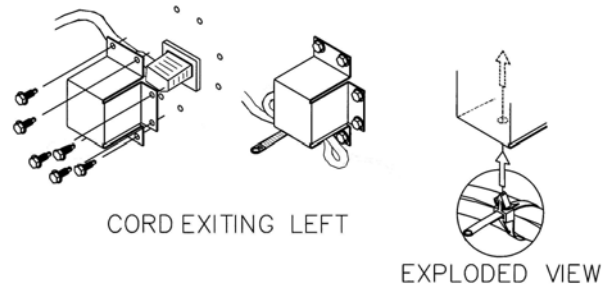

Figure 8.3 Power Cord and Protective Cover

## 8-12. STORING THE VENDOR

If the vendor is to be stored without power for longer than a day or two, please use the following instructions. These instructions are similar to those used to store any freezer.

1. Open the vendor door to cause the sliding door to retract.
2. Unplug the vendor from the power outlet.
3. Remove any food products from the vendor.
4. Clean the inside of the vendor using the general directions given in Sections 8-4 and 8-5.
5. Leave the vendor door open for a day to allow the interior to thoroughly dry.
6. Close the vendor door and lock it to protect the interior.
7. If the vendor is being moved follow the handling and setup procedures given in Section 4.





### 9.0 WIRING DIAGRAM

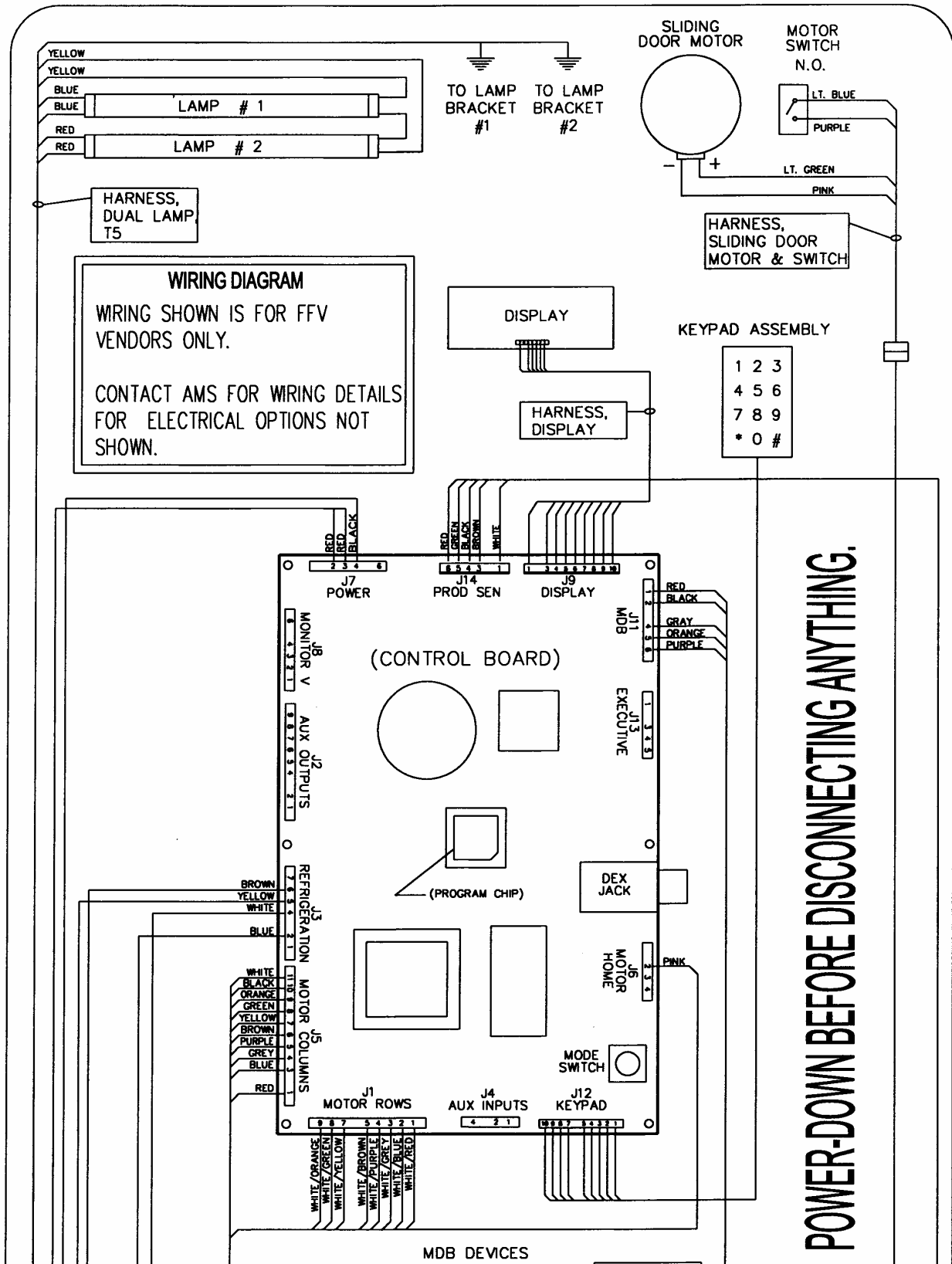

**WIRING DIAGRAM**  
 WIRING SHOWN IS FOR FFV VENDORS ONLY.  
 CONTACT AMS FOR WIRING DETAILS FOR ELECTRICAL OPTIONS NOT SHOWN.

Figure 9.1 Typical Wiring Diagram, Sheet 1 of 4

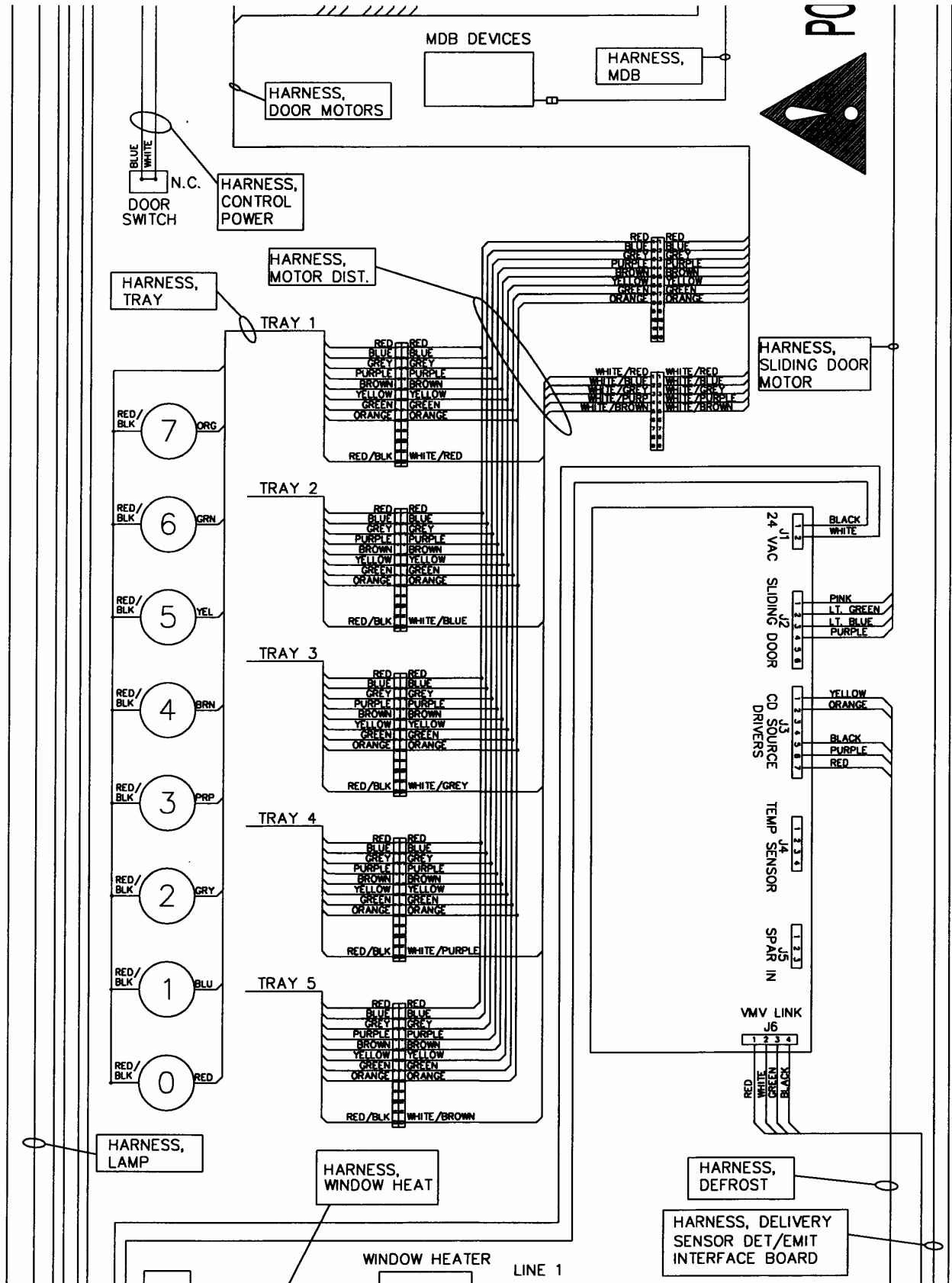

Figure 9.1 Wiring Diagram, Sheet 2 of 4



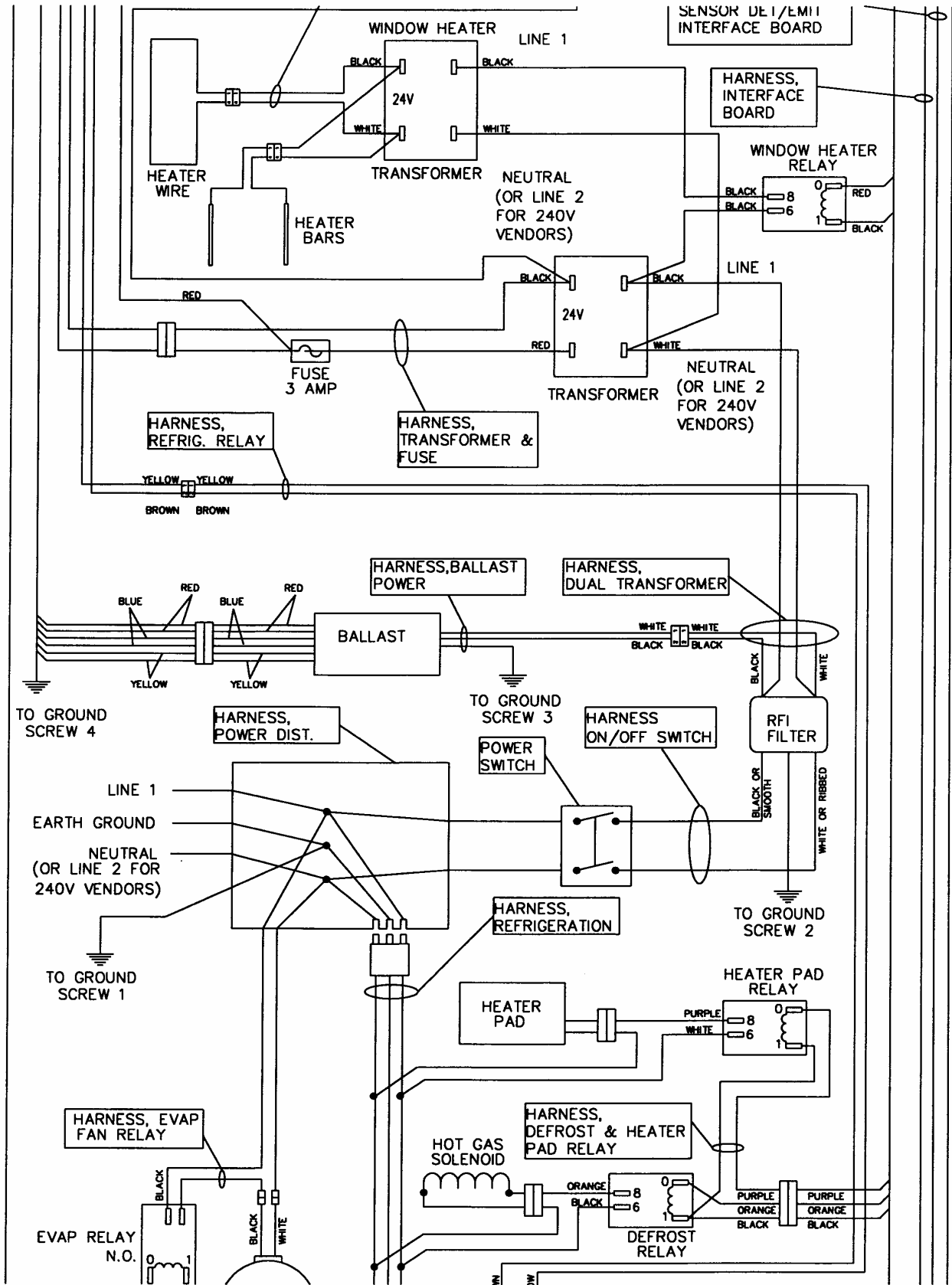
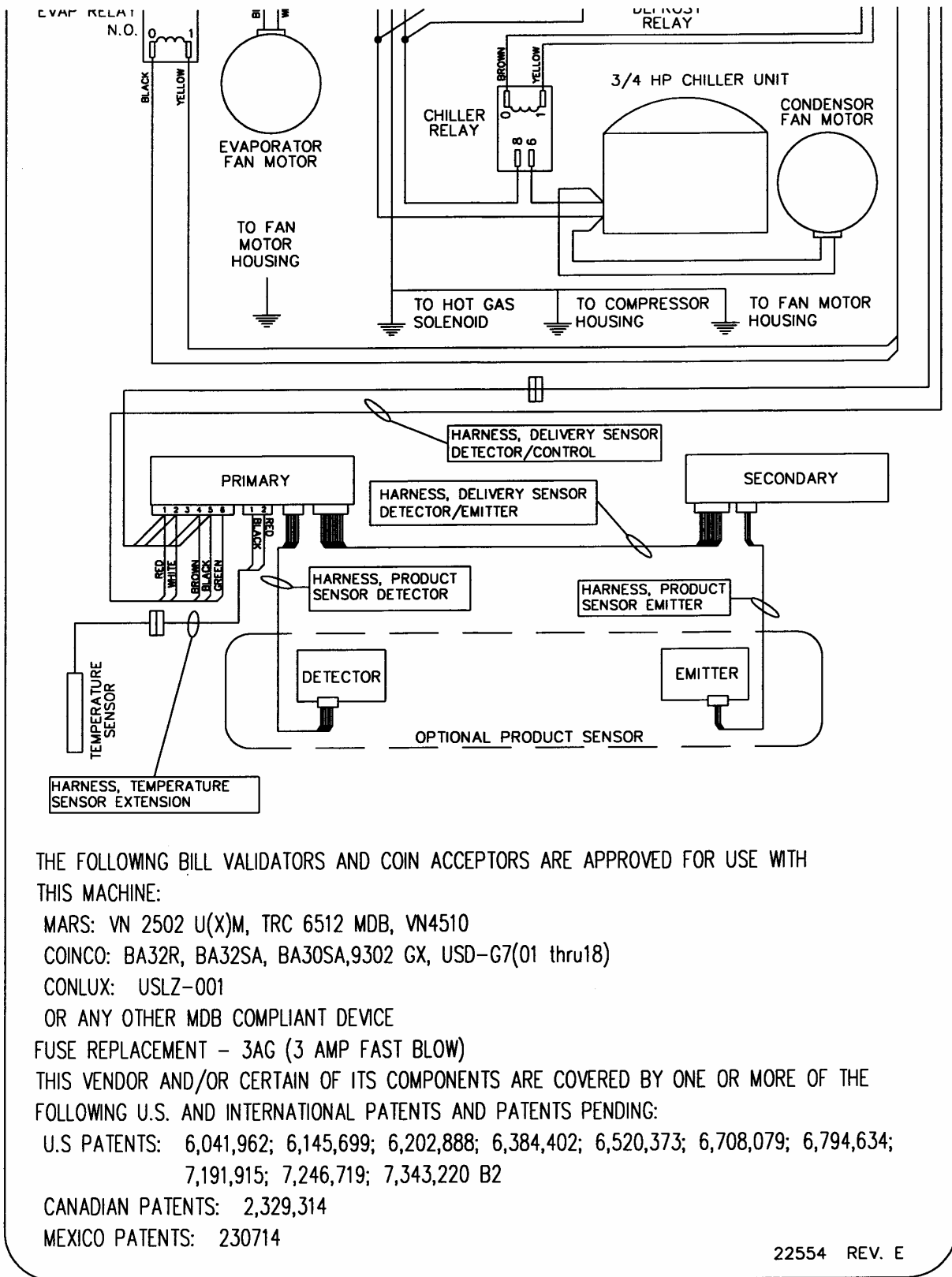

Figure 9.1 Typical Wiring Diagram, Sheet 3 of 4



22554 REV. E

Figure 9.1 Typical Wiring Diagram, Sheet 4 of 4

**10.0 SUPPORTED DEX FIELDS**

CA101	Coin mechanism serial number
CA102	Coin mechanism model number
CA103	Coin mechanism software revision
CA201	Value of cash sales since initialization
CA202	Number of cash vends since initialization
CA203	Value of cash sales since last reset
CA204	Number of cash vends since last reset
CA301	Value of cash in since last reset
CA302	Value of cash to the cash box since last reset
CA303	Value of cash to tubes since last reset
CA304	Value of bills in since last reset
CA305	Value of cash in since initialization
CA306	Value of cash to the cash box since initialization
CA307	Value of cash to the tubes since initialization
CA308	Value of bills in since initialization
CA401	Value of cash dispensed since last reset
CA402	Value of cash manually dispensed since last reset
CA403	Value of cash dispensed since initialization
CA404	Value of cash manually dispensed since initialization
CA601	Number of DEX reads performed since initialization
CA602	Number of door openings since initialization
CA701	Value of cash discounts since last reset
CA702	Value of cash discounts since init
CA703	Number of cash discounts since last reset
CA704	Number of cash discounts since init
CA801	Value of cash overpay since last reset
CA1001	Value of cash filled since last reset
CA1002	Value of cash filled since initialization
CB101	Control board serial number
CB102	Control board model number
CB103	Control board software revision
DA201	Value of card sales since initialization
DA202	Number of card vends since initialization
DA203	Value of card sales since last reset
DA204	Number of card vends since last reset
DA401	Value credited to card since initialization
DA402	Value credited to card since last reset
DA501	Value of card discounts since last reset
DA502	Number of cashless discounts since last reset
DA503	Value of card discounts since initialization
DA504	Number of cashless discounts since init

EA401	Date of installation
EA402	Time of installation
EA403	Installation terminal/interrogator identification
EA701	Number of power outages since last reset
EA702	Number of power outages since initialization
EA301	Number of reads since initialization
EA302	Date of the current read out
EA303	Time of current read out
EA304	This terminal/interrogator identification
EA305	Date of the last read out
EA306	Time of the last read out
EA307	Last terminal/interrogator identification
ID101	Machine serial number
ID102	Machine model number
ID103	Machine build standard
ID107	VIDTS stage
ID108	VIDTS revision
ID401	Decimal point position
ID402	International telephone country code
ID403	Currency description
PA101	Product number
PA102	Product price
PA201	Number of products vended since initialization
PA202	Value of paid products since initialization
PA203	Number of products vended since last reset
PA204	Value of paid product sales since last reset
PA205	Number of discounts since init
PA206	Value of discounts since init
PA207	Number of discounts since last reset
PA208	Value of discounts since last reset
PA401	Number of free vends since initialization
TA201	Value of vend token sales since initialization
TA202	Number of token vends since initialization
TA203	Value of vend token sales since last reset
TA204	Number of vend token vends since last reset
TA205	Value of value token sales since initialization
TA207	Value of value token sales since last reset
TA208	Number of value token vends since last reset
VA101	Value of all paid sales since initialization
VA102	Number of all paid vends since initialization
VA103	Value of all paid sales since last reset
VA104	Number of all paid sales since last reset
VA105	Value of discounted paid vends since init
VA106	Number of discounted paid vends since init
VA107	Value of discounted paid vends since last reset
VA108	Number of discounted paid vends since last reset
VA301	Value of all free vends since initialization
VA302	Number of all free vends since initialization
VA303	Value of all free vends since last reset
VA304	Number of all free vends since last reset

## **11.0 OPTIONAL EQUIPMENT**

**Part No. 23282 - Kit, Candy Pusher**

The candy pusher is an adjustable bar that mounts to any tray divider to keep tall candies from falling sideways. Four of these are provided with the standard glass front vendor.

**Part No. 23283 - Kit, Helix Splitter**

The helix splitter is a plastic divider that can be inserted into a small helix to divide each coil into two product openings, thereby doubling product capacity. The helix splitter works best with narrow products such as Life Savers.

**Part No. 23284 - Kit, Cup Rail, Small Helix**

**Part No. 23285 - Kit, Cup Rail, 4" Helix**

The cup rail is a flat plastic bar that can be placed inside the helix to provide a flat surface for packages that otherwise do not stay upright when placed in a helix. The bar may be installed either vertically or horizontal.

**Part No. 20664 - Kit, Banking Spacer**

**P/N 3302, AMS Sensit II Utility CD**

**P/N 20786, Harness, Chip Programming**

Load Sensit II software into the vendor, configure the vendor software, and/or download files using the AMS Utility software, the cable and the vendor software



## **12.0 LIMITED WARRANTY**

Automated Merchandising Systems Inc. (AMS) warrants this equipment to the Original Purchaser only, for a period of one (1) year from the date of shipment, to be free under normal use and service from defects in material or workmanship, and for three (3) years on the refrigeration unit, electronic control board, and the two sensor boards. The refrigeration unit consists of the compressor, fan motors, relay, and the sealed components of the system. Light bulbs, glass, and painted surfaces are not covered by this warranty.

Should any part prove defective within the warranty period, AMS will repair or replace (at its option) the defective component. AMS will provide normal ground shipment for parts replaced under warranty. This warranty does not cover the labor or other costs associated with removal and reinstallation of a defective component. All defective components, at the option of AMS, are to be returned, properly packaged, freight prepaid, to AMS or to the authorized dealer or distributor from whom the equipment was purchased for verification of the defect. Prior to returning any parts for replacement the customer is to contact the AMS Service Department at (304) 725-6921 for return authorization. AMS reserves the right to refuse any collect shipment.

This warranty applies only if the equipment has been serviced and maintained in strict accordance with the instructions presented in this service manual and no unauthorized repair, alteration, or disassembly has been done. Any defects caused by improper power source, abuse of the product, accident, alteration, vandalism, improper service techniques, or damage incurred during return shipment due to improper packaging will not be covered by this warranty. Likewise, any equipment that has had the serial number removed, defaced or otherwise altered will not be covered by this warranty.

AMS reserves the right to make changes or improvements in its products without notice and without obligation, and without being required to make corresponding changes or improvements in equipment already manufactured or sold.

